

Firefighter Safety Switch

CRS005002P0 - 1 strings – IP66



Electrical data (according to IEC 60947-3/UL508i)

Thermal current I_{th} (-20°C - +50°C)

up to 40°C	38A
-20°C - +50°C	32A

String Voltage

800Vdc	DC-PV1	38A
1000 Vdc	DC-PV1	38A
1500 Vdc	DC-PV1	32A

Mechanical data

Minimum number of operations without load (cycles)	10000
Number on-load operations (cycles)	1500

*Working voltage at 100-270Vac

Rated voltage 230Vac

Maximum temperature before automatic shutdown 70°C

Standards

IEC 60947-3



Quality Telergon, SAU

ISO 9001 & 14001



Codes

Case size	Poles	Strings	Reference
1	2P	1 strings	CRS005002P0

Dimensions

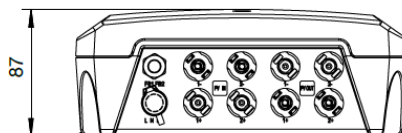
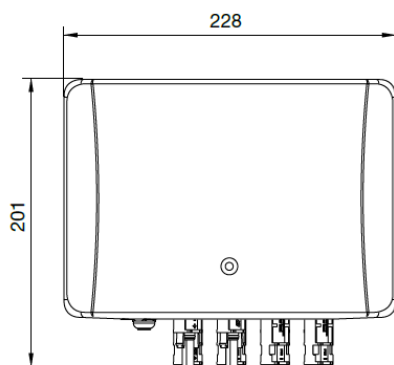

You will find detailed information about our products on our web site www.telergon.com



Firefighter Safety Switch
CRS005002P0

TELERGON, SAU
Data subject to change without
notice (printed: 22/05/2024)