

# LE-03MQ CT

Electric energy meter

1-phase/ 3-phase

Bidirectional with network parameters analysis



User manual  
v. 4.5 (191120)

# CONTENTS

1. PURPOSE.....	4
2. UNIT CHARACTERISTIC .....	4
2.1. Measured values .....	4
2.2. Current transformers (CT) .....	4
2.3. RS-485 communication port and Modbus RTU protocols .....	5
2.4. Pulse output .....	5
3. START-UP SCREENS .....	5
4. OPERATOR PANEL .....	6
4.1. Voltage and current, harmonic .....	6
4.2. Frequency, power factor and demand .....	7
4.3. Power .....	8
4.4. Energy measurements .....	9
5. SETUP .....	10
5.1. Setup entry methods .....	10
5.1.1. Navigation .....	10
5.1.2. Number entry procedure .....	10
5.2. Setup parameters .....	11
5.2.1. Entry into configuration menu .....	11
5.2.2. RS-485 communication .....	11
5.2.2.1. (Slave ID) Address .....	11
5.2.2.2. Baud rate .....	12
5.2.2.3. Parity .....	13
5.2.2.4. Stop bits .....	13
5.2.3. Current transformers .....	14
5.2.4. Measuring voltage .....	15
5.2.5. Pulse output .....	16
5.2.5.1. Energy setup .....	16
5.2.5.2. Pulse rate .....	17
5.2.5.3. Pulse duration .....	17
5.2.6. Demand Integration Time (DIT) .....	18

---

5.2.7. Backlit setup .....	19
5.2.8. Measuring system .....	19
5.2.9. CLR .....	20
5.2.10. Change password .....	21
6. TECHNICAL SPECIFICATION .....	22
6.1. Measured parameters .....	22
6.1.1. Voltages and currents .....	22
6.1.2. Power factor, frequency and demand .....	22
6.1.3. Energy measurements .....	23
6.2. Terminal .....	23
6.3. Accuracy .....	23
6.4. Power supply and power meter .....	23
6.5. Measurement inputs .....	23
6.6. Pulse outputs .....	24
6.7. RS-485 output for Modbus RTU .....	24
6.8. Reference conditions of influence quantities .....	24
6.9. Environment .....	25
6.10. Structure .....	25
6.11. Compliance and sealing .....	25
7. DIMENSIONS .....	26
8. WIRING DIAGRAM .....	26
8.1. Meter's power supply .....	26
8.2. Measuring systems .....	27
9. MODBUS PROTOCOLE REGISTERS.....	28
9.1. Input registers .....	28
9.2. Setup registers .....	32

---

## 1. PURPOSE

LE-03MQ CT is a static (electronic) calibrated electricity meter of single-phase or three-phase alternating current in a direct system. It is used for reading and recording of consumed electric energy and mains parameters with remote readout via a wired RS-485 network. The meter works with current transformers (CT) with 1 A or 5 A secondary current. The configuration of the meter is done through the configuration menu accessible from the front panel and the communication port according to the software features of the Modbus RTU protocol.

## 2. UNIT CHARACTERISTICS

### 2.1. Measured value

The unit can measure and display:

- ✓ line voltage and THD% (total harmonic distortion) of all phases
- ✓ line frequency
- ✓ currents, current demands and current THD% of all phases
- ✓ power, maximum power demand and power factor
- ✓ active energy imported and exported
- ✓ reactive energy imported and exported

### 2.2. Current transformers (CT)

The meter works with current transformers (CT) with 1 A or 5 A secondary current. The appropriate value of rate and the secondary current of the connected transformer should be set in the meter.

For example: using a 100/5 A current transformer, you should set the secondary current CT2 to 5 and the rate CRate to 0020. To get the CT rate to enter you need to divide a primary current value by the value of the secondary current ( $100/5 = 20$ ).

### **WARNING!**

**The CT rate can be set only once. It is a legal requirement of the MID Directive. Once set the rate cannot be changed. This applies to both parameters: CT2 and CT rate.**

### 2.3. RS-485 communication port and Modbus RTU protocols

The meter is equipped RS-485 port with Modbus RTU protocols.

The RS-485 communication port allows you to connect meters into a network of remote reading.

### 2.4. Pulse output

The meter has two pulse outputs for mapping the counting of active and reactive energy. Output 1 - terminals 9/10 - programmable, can be set to work for active or reactive energy and parameters: impulsing and pulse length.

Output 2 - Terminals 11/12 - for active energy, impulsing is 3200 pulse / kWh.

## 3. START-UP SCREENS

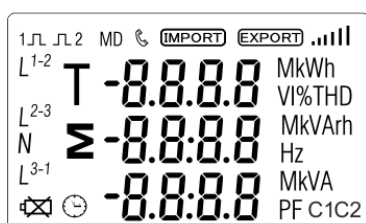

The first screen lights up all display segments and can be used as a display check.

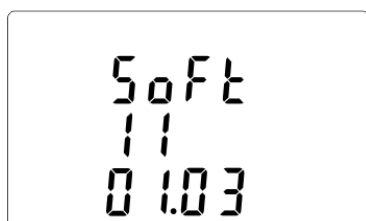

Information about software version.

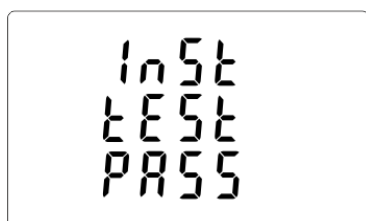

The interface performs a self-test and indicates the result if the test passes.

## 4. OPERATOR PANEL

Buttons features:



Select the voltage and current display screens.  
In set up mode, this is the "Left" or "Back" button.



Select the frequency and power factor display screens.  
In set up mode, this is the "Up" button.



Select the power display screens.  
In set up mode, this is the "Down" button.



Select the energy display screens.  
In set up mode, this is the "Enter" or "Right" button.

### 4.1. Voltage and current, harmonic

Each successive pressing of the  button selects a new range:



Phase to neutral voltages (3p4w).



Current on each phase.

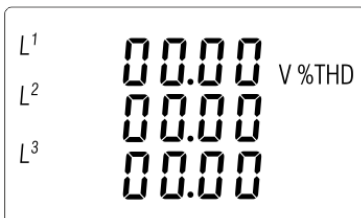

Phase to neutral voltage THD% (3p4w).



Current THD% for each phase.

## 4.2. Frequency, power factor and demand

Each successive pressing of the  button selects a new range:

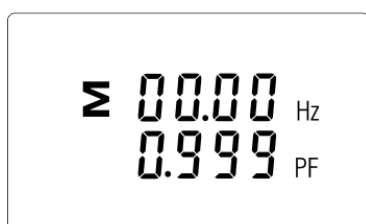

Frequency and power factor (total).

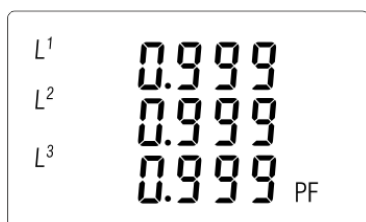

Power factor of each phase.



Maximum power demand.



Maximum current demand.

### 4.3. Power

Each successive pressing of the  button select a new range:



Instantaneous active power in kW.



Instantaneous reactive power in kVAr.



Instantaneous volt-amps in kVA.

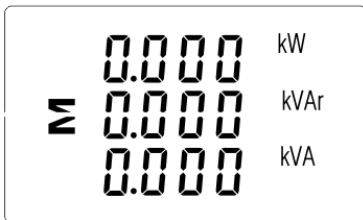

Total: kW, kvar, kVA



#### 4.4. Energy measurements

Each successive pressing of the  button selects a new range:

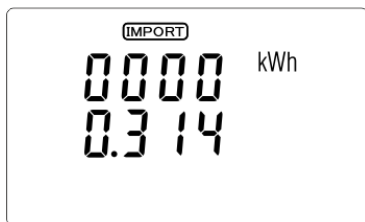

Imported active energy in kWh



Exported active energy in kWh



Imported reactive energy in kVArh



Exported reactive energy in kVArh

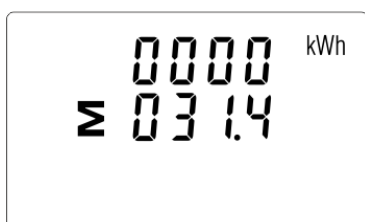

Total active energy in kWh



Total reactive energy in kVArh

The total value of the given energy is presented in two rows.











The top row presents the higher values, the bottom row presents the lower values + fractional value.  
For example:  
Indications: 0027 - top row; 845.3 - bottom row presents the value of 27845.3 kWh.

## 5. SETUP

### 5.1. Setup entry methods





Some menu items, such as password and CT, require a four-digit number entry while others, such as supply system, require selection from a number of menu options. After confirming the settings the meter confirms the adoption of a new parameter by displaying for a moment the word "good".

#### 5.1.1. Navigation

1.   Transition to the next position configuration menu.
2. Press  to confirm your selection.
3.   Edition of value (change of position number by +/- 1)
4. Having selected an option from the current layer, press  to confirm your selection. The SET indicator will appear.
5.  Back to the higher menu level. The SET indicator will disappear and you will be able to use the buttons,   again to select further options.
6.  exit the configuration menu to the measurements screen.

#### 5.1.2. Number entry procedure

When setting up the unit, some screens require the entering of a number. In particular, on entry to the setting up section, a password must be entered. Digits are set individually, from left to right. The procedure is as follows:

1. The current digit to be set flashes and is set using the  and  buttons.
2. Press  to confirm each digit setting. The SET indicator appears the last digit has been set.
3. After setting the last digit, press  to exit the number setting routine. The SET indicator will be removed.

## 5.2. Setup parameters

### 5.2.1. Entry into configuration menu

To enter setup mode, pressing the  button for 2 seconds, until the password screen appears.

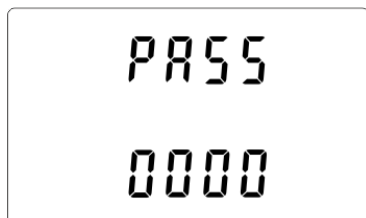

Setting up is password-protected so you must enter the correct password (default "1000") before processing.

Press the  button for 2 seconds.

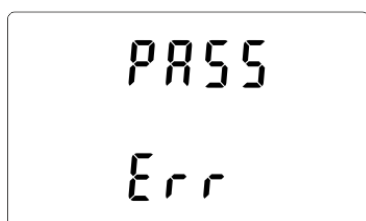

If an incorrect password is entered, the display will show:

PASS Err

To exit setting-up mode, press  repeatedly until the measurement screen is restored.



### 5.2.2. RS-485 communication

Setting the communication port parameters.

#### 5.2.2.1. (Slave ID) Address

(Range 001 to 247)



From the set up menu, use  and  buttons to select the address ID.



Press  button to enter the selection routine. The current setting will be flashing.



Use **P** and **MD/PF/HZ** buttons to choose Modbus address (001 to 247).  
Press **E** button to confirm the selection.

Press **V/A ESC** button to return the main set up menu.

#### 5.2.2.2. Baud rate



From the set up menu, use **P** and **MD/PF/HZ** buttons to select the Baud rate option.



Press **E** button to enter the selection routine.  
The current setting will flash.



Use **P** and **MD/PF/HZ** buttons to choose baud rate:  
2,4 / 4,8 / 9,6 / 19,2 / 38,4 [kbps].  
Press **E** button, to confirm the selection.

Press **V/A ESC** button to return the main set up menu.

### 5.2.2.3. Parity



From the set up menu, use **P** and **MD/ PF/HZ** buttons to select the parity option.



Press **E** to enter the selection routine. The current setting will flash.



Use **P** and **MD/ PF/HZ** buttons to choose parity EVEN/ODD/NONE (default). Press **E** button to confirm selection.

Press **V/A ESC** button to return to the main set up menu.

### 5.2.2.4. Stop bits

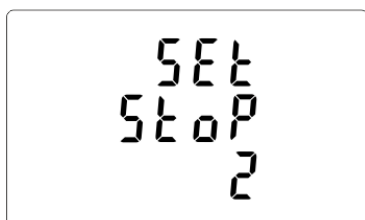

From the set up menu, use **P** and **MD/ PF/HZ** buttons to select the stop bit option.



Press **E** to enter the selection routine. The current setting will flash.



Use **P** and **MD/PF/HZ** buttons to choose stop bits: 2 or 1.  
 NOTE: Default value is 1. Only in case parity set up NONE, to change stop bits to 2.  
 Press **E** to confirm the selection.

Press **V/A ESC** to return to the main set up menu.

### 5.2.3. Current transformers

Setting currents values of the connected transformers.



Use the **P** and **MD/PF/HZ** buttons in the configuration menu to select the value of the CT.



Secondary current

Hold down **E** to enter the secondary current setting mode: 5 A/1 A.  
 Hold down **E** to confirm selection.



CT rate

Press **E** to display the rate setting screen.  
 Range of 0001 to 9999.  
 Hold down **E** to confirm selection.

For example: for 100/5 A current transformer set the CT2 to 5 and rate to 20.  
 To get the CT rate you need to divide a primary current value by the value of the secondary current (100/5 = 20).

### WARNING!

The CT rate can be set only once. It is a legal requirement of the MID Directive. Once set the rate cannot be changed.  
 This applies to both parameters: CT2 and CT rate.

### 5.2.4. Measurement voltage

Setting the value of the input voltage directly or through transformers.

**For half-indirect 1- or 3-phase measurement set the value PT2 to 400 and PTrate to 1.**



Use the buttons   in the configuration menu to select the PT option.



Input voltage.

Hold down  to enter the PT2 input voltage setting mode: from 100 to 500.

Hold down  to confirm selection.

**For half-indirect 1- or 3-phase measurement set the value to 400.**



PT rate.

Press  to display the rate setting screen.

Range of 0001 to 9999.

Hold down  to confirm selection.

**For half-indirect 1- or 3-phase measurement set the value to 1.**

## 5.2.5. Pulse output

Pulse output configuration no. 1.

### 5.2.5.1. Energy setup

The output can be set to provide a pulse for a defined amount of energy active (kWh) or reactive (kvarh).



From the setup menu, use **P** and **MD/ PF/HZ** buttons to select the pulse output option.



Press **E** to enter the selection routine. The unit symbol will flash.



Use **P** and **MD/ PF/HZ** buttons to choose kWh or kVArh.

Press **E** to confirm selection.

Press **V/A ESC** to return to the main set up menu.



### 5.2.5.2. Pulse rate

Setup value option kWh/kvarh per 1 pulse. Values: 0.01 / 0.1 / 110 / 100.



From the setup menu, use **P** and **MD/PF/HZ** buttons to select the pulse rate option.



Press **E** to enter the selection routine.

The current setting will flash.

Use **P** and **MD/PF/HZ** buttons to select value: 0,01 / 0,1 / 1 / 10 / 100 per pulse.

Press **E** to confirm selection.

Press **V/A ESC** to return to the main set up menu.

### 5.2.5.3. Pulse duration

Option of setting pulse length for output. Values: 200, 100 or 60 ms.



From the setup menu, use **P** and **MD/PF/HZ** buttons to select the pulse width option.



Press **E** to enter the selection routine.

The current setting will flash.

Use **P** and **MD/PF/HZ** buttons to choose value: 200, 100 or 60 ms.

Press **E** to confirm the selection.

Press **V/A ESC** to return to the main set up menu.

### 5.2.6. DIT - Demand Integration Time

The options are: 5, 10, 15, 30, 60 minutes.



From the setup menu, use and buttons, to select the DIT option.  
The screen will show the currently selected integration time.



Press to enter the selection routine.  
The current time interval will flash.



Use and buttons to select the time required.



Press to confirm the selection.  
SET indicator will appear.

Press to exit the DIT selection routine and return to the menu.

### 5.2.7. Backlit setup

The meter allows you to set the time of the backlight.



Time: 0 / 5 / 10 / 30 / 60 / 120 minutes.

**Value 0 means that the backlight is always on.**



Default lasting time is 60 minutes.  
If it's setted as 5, the backlit will be off in 5 minutes from the last time operation on the meter.



Use  and  buttons to select the time.  
Press  to confirm the selection.



### 5.2.8. Measuring system

Setup option for measuring system:

1P2W – 1-phase 2-wires system;

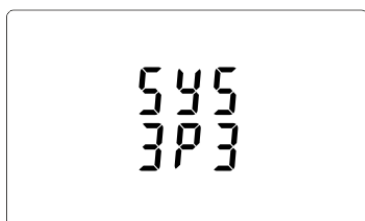
3P3W – 3-phases 3-wires system (without neutral wire); 3P4W – 3-phases 4-wires



From the set up menu, use  and  buttons to select the system option.  
The screen will show the currently selected power supply.

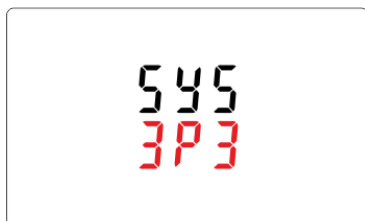

Press  to enter the selection routine.  
The current selection will flash.



Use **P** and **MD/ PF/HZ** buttons to select the required system option: 1P2(W), 3P3(W), 3P4(W).



Press **E** to confirm selection.  
SET indicator will appear.

Press **V/A ESC** to exit the system selection routine and return to the menu. SET will disappear and you will be returned to the main set up menu.

### 5.2.9. CLR

The meter provides a function to reset the maximum demand value of current and power.



From the setup menu, use **P** and **MD/ PF/HZ** buttons to select the reset option.

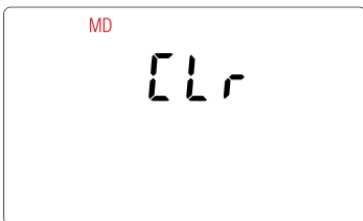

Press **E** to enter the selection route.  
The MD will flash.  
Press **E** to confirm selection.

Press **V/A ESC** to return to the main set up menu.

### 5.2.10. Change password





Press  and  buttons to choose the change password option.



Press and hold  to enter the change password routine. The new password screen will appear with the first digit flashing.



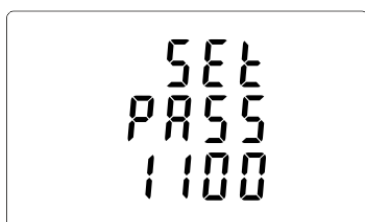

Use  and  buttons to set the first digit and press  to confirm your selection. The next digit will flash.

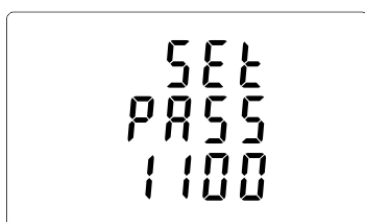

Repeat the procedure for the remaining three digits.



After setting the last digit, press and hold  to confirm selection.

Press  to exit the number setting routine and return to the setup menu. SET will be removed.

## 6. TECHNICAL SPECIFICATION

### 6.1. Measured parameters

The unit can monitor and display the following parameters of:

1P2W – 1-phase 2-wire system (230V+N)

3P3W – 3-phases 3-wire system (3×400V; without neutral wire)

3P4W – 3-phases 4-wire system (3×230V+N)

#### 6.1.1. Voltages and currents

Reference voltage: 3×230/400V

Base current: 0,25÷10A

Maximum current: 100A

Minimum current measured: 0,02A

Overload: 30×I<sub>max</sub>/10ms

Measuring range phase voltages: 100÷289 V AC (for 1P2W and 3P4W system).

Range of interphase voltages: 173÷500 V AC (for 3P3W system).

Percentage overall factor of total harmonic distortion (THD%) for the phase voltages (for systems 1P2W and 3P4W).

Percentage overall factor of total harmonic distortion (THD%) for interphase voltages (for 3P3W system).

Percentage overall factor of total harmonic distortion (THD%) for the phase currents.

Insulation: 4 kV/1 min; 6 kV/1,2 μs

#### 6.1.2. Power factor and frequency and max. demand

- ✓ Frequency in Hz
- ✓ Instantaneous power:
  - active: 0÷3600 MW
  - reactive: 0÷3600 Mvar
  - volt-amps: 0÷3600 MVA
- ✓ Maximum power consumption (with RESET function)
- ✓ Maximum power consumption neutral wire (with RESET function)

### 6.1.3. Energy measurements

- ✓ Imported/exported active energy: 0÷9999999,9 kWh
- ✓ Imported/exported reactive energy: 0÷9999999,9 kVArh
- ✓ Total active energy: 0÷9999999,9 kWh
- ✓ Total reactive energy: 0÷9999999,9 kVArh

### 6.2. Terminal

Current inputs	2.5mm <sup>2</sup> screw terminals
Voltage inputs	2.5mm <sup>2</sup> screw terminals
Pulse outputs	2.5mm <sup>2</sup> screw terminals
RS-485 port	2.5mm <sup>2</sup> screw terminals

### 6.3. Accuracy

Measurement class	B
Voltage	0.5% of range maximum
Current	0.5% of nominal
Frequency	0.2% of mid-frequency
Power factor	1% of unity (0.01)
Active power (W)	±1% of range maximum
Reactive power (VAr)	±1% of range maximum
Apparent power (VA)	±1% of range maximum
Active energy (Wh)	±1% 1 IEC 62053-21
Reactive energy (VArh)	±1% of range maximum
Total harmonic distortion	1% up to 31st harmonic
Response time to step input	1s, typical, to >99% of final reading at 50 Hz.

### 6.4. Power supply and power meter

85÷275 V AC 50/60 Hz ±10%  
 120÷380 V DC ±20%  
 <10VA; <2W

### 6.5. Measurement inputs

Voltage: 3×230V/400V  
 Current: 100A

## 6.6. Pulse outputs

Outputs type: OC (open collector); 27V DC/50mA

Pulse:

Pulse output 1 is configurable: for kWh or kvarh. Value set up kWh/kvarh per 1 pulse:

0,01 = 10 Wh/VArh

0.1 = 100 Wh/VArh

1 = 1 kWh/kVArh

10 = 10 kWh/kVArh

100 = 100 kWh/kVArh

1000 = 1000 kWh/kVArh.

Pulse output 2 is non-configurable for kWh: 3200 pulse/kWh

Pulse width:

Output 1 - configurable: 200 / 100 / 60 ms

Output 2 - non-configurable: 200ms

## 6.7. RS-485 output for Modbus RTU

Baud rate: 2400, 4800, 9600, 19200, 38400 bps

Parity: NONE – default / ODD / EVEN

Stop bits: 1 / 2

Network address: 1÷247

## 6.8. Reference conditions of influence quantities

Influence quantities are variables that affect measurement errors to a minor degree.

Accuracy is verified under nominal value (within the specified tolerance) of these conditions.

Ambient temperature	23°C ±1°C
Input frequency	50 or 60 Hz ±2%
Input waveform	sinusoidal (distortion factor <0,005)
Auxiliary supply voltage	±1% nominal
Auxiliary supply frequency	±1% nominal
Auxiliary supply waveform (if AC)	sinusoidal (distortion factor <0,05)
Magnetic field of external origin	terrestrial flux



## 6.9. Environment

Operating temperature	-25÷55°C
Storage temperature	-40÷70°C
Relative humidity	0÷95%, non-condensing
Altitude	Up to 3000 m
Warm up time	1 minute
Wibration	10÷50Hz, IEC 60068-2-6, 2 g
Limitation	30g in 3 planes

## 6.10. Structure

Mounting	on DIN rail
Cover	UL94 V-0 self-extinguishing material
Ingress protection	IP51 (inside)

## 6.11. Compliance and sealing

2004/22/EC Directive

Certificate number: 0120/SG S0216.

The meter is marked with individual serial number allowing its explicit identification.

The marking is laser engraved and cannot be removed.

The meter has sealable input and output terminal cover to prevent any attempts to bypass the meter.

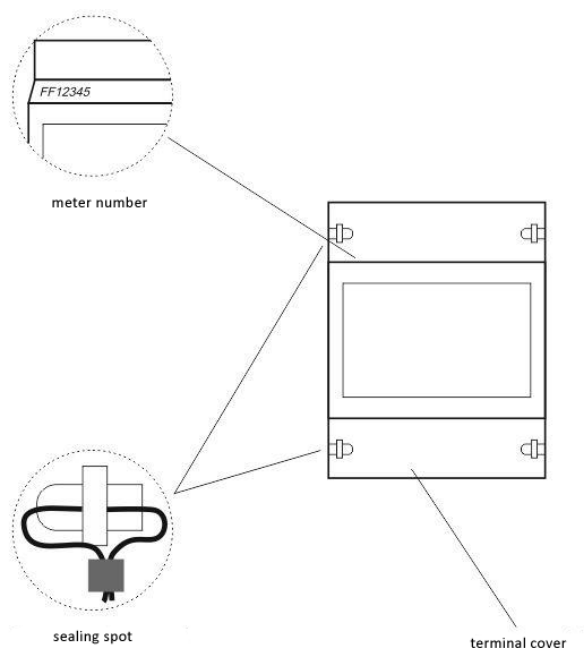

## 7. DIMENSIONS

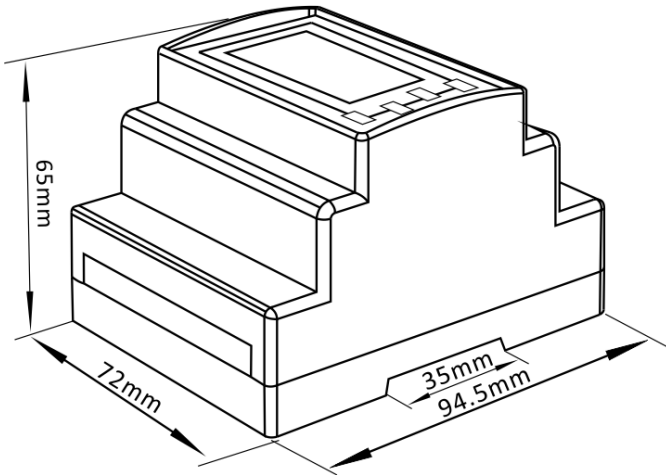

## 8. WIRING DIAGRAM

### 8.1. Meter's power supply

The meter is not powered from the voltage measurement inputs. It requires separate power supply from any phase of the measuring system.

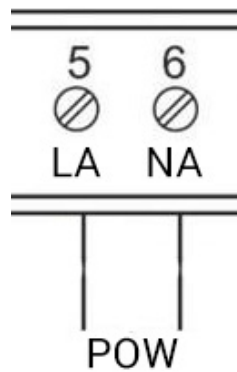

## 8.2. Measuring systems

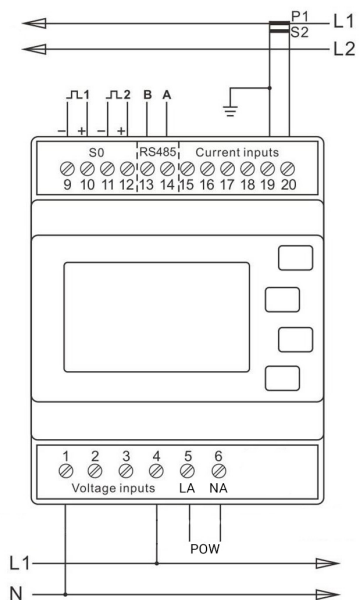

Single phase two wires system

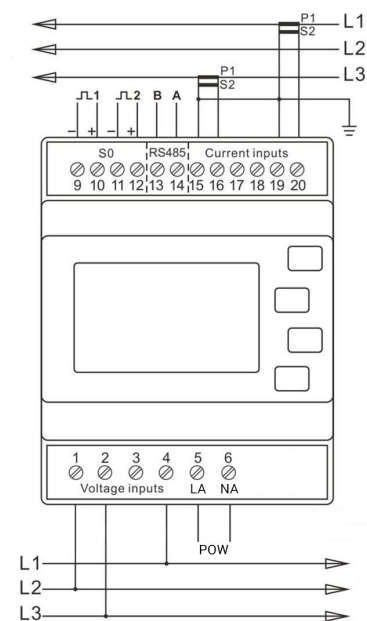

Three phases three wires system

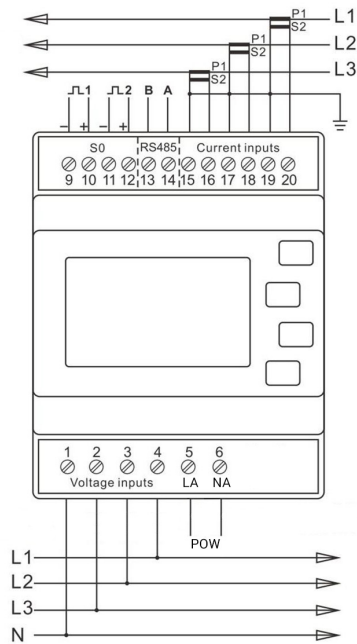

Three phases four wires system

## 9. MODBUS PROTOCOL REGISTERS

### 9.1. Input registers

Input registers are used to indicate the present values of the measured and calculated electrical quantities. Each parameter is held in two consecutive 16-bit register (FLOAT). The following table details the 3X register address, and the values of the address bytes within the message. A (\*) in the column indicates that the parameter is valid for the particular wiring system. Any parameter with a cross(X) will return the value zero. Each parameter is held in the 3X registers. Modbus Protocol function code 04 is used to access all parameters.

The meter can send up to 40 values in a single data exchange, therefore the maximum number of requested registers may be 80. Exceeding the 80 parameter limit will cause a Modbus Protocol exception code to be returned.

For example, to request:

- Amps 1      Start address=0006
- No. of registers=0002
- Amps 2      Start address=0008
- No. of registers=0002

Each request for data must be restricted to 40 parameters or less. Exceeding the 40 parameter limit will cause a Modbus Protocol exception code to be returned.

Register address (Dec/Hex)	Measuring parameter		System		
	Description	Units	3P4W	3P3W	1P2W
0 / 00	L1 (L-N) Phase voltage	V	√	X	√
2 / 02	L2 (L-N) Phase voltage	V	√	X	X
4 / 04	L3 (L-N) Phase voltage	V	√	X	X
6 / 06	L1 Current strength	A	√	√	√
8 / 08	L2 Current strength	A	√	√	X
10 / 0A	L3 Current strength	A	√	√	X
12 / 0C	L1 Active power	W	√	X	√
14 / 0E	L2 Active power	W	√	X	√
16 / 10	L3 Active power	W	√	X	X
18 / 12	L1 Apparent power	VA	√	X	√
20 / 14	L2 Apparent power	VA	√	X	X
22 / 16	L3 Apparent power	VA	√	X	X
24 / 18	L1 Reactive power	Var	√	X	√
26 / 1A	L2 Reactive power	Var	√	X	X
28 / 1C	L3 Reactive power	Var	√	X	X
30 / 1E	L1 Power factor	-	√	X	√
32 / 20	L2 Power factor	-	√	X	X
34 / 22	L3 Power factor	-	√	X	X
36 / 24	L1 Phase angle	Degrees	√	X	√
38 / 26	L2 Phase angle	Degrees	√	X	X
40 / 28	L3 Phase angle	Degrees	√	X	X
42 / 2A	Average phase voltage among phase and neutral wire	V	√	X	X
46 / 2E	Average line current	A	√	√	√
48 / 30	Sum of phase currents	A	√	√	√
52 / 34	Total system power	W	√	√	√
56 / 38	Total system volt amps	VA	√	√	√
60 / 3C	Total system Var	Var	√	√	√
62 / 3E	Total system power factor (*1)	-	√	√	√
66 / 42	Total system phase angle	Degrees	√	√	√
70 / 46	Frequency of supply voltages	Hz	√	√	√

72 / 48	Imported active energy	kWh/ MWh	V	V	V
74 / 4A	Exported active energy	kWh/ MWh	V	V	V
76 / 4C	Imported reactive energy	kVarh/ MVarh	V	V	V
78 / 4A	Exported reactive energy	kVarh/ MVarh	V	V	V
80 / 50	Apparent power	kVah/ MVAh	V	V	V
82 / 52	Ah since last reset	Ah/kAh	V	V	V
84 / 54	Total system power demand (*2)	W	V	V	V
86 / 56	Maximum total system power demand (*2)	W	V	V	V
100 / 64	Total system VA demand (*2)	VA	V	V	V
102 / 66	Maximum total system VA demand	VA	V	V	V
104 / 68	Neutral current demand	A	V	X	X
106 / 6A	Maximum neutral current demand	A	V	X	X
200 / C8	L1-L2 interphase voltage	W	V	V	X
202 / CA	L2-L3 interphase voltage	W	V	V	X
204 / CC	L3-L1 interphase voltage	W	V	V	X
206 / CE	Average interphase voltage	W	V	V	X
224 / E0	Neutral current	A	V	X	X
234 / EA	Phase 1 L/N volts THD	%	V	X	V
236 / EC	Phase 2 L/N volts THD	%	V	X	X
238 / EE	Phase 3 L/N volts THD	%	V	X	X
240 / F0	Phase 1 current THD	%	V	V	V

242 / F2	Phase 2 current THD	%	V	V	X
244 / F4	Phase 3 current THD	%	V	V	X
248 / F8	Average line to neutral volts THD	%	V	X	V
250 / FA	Average line current THD	%	V	V	V
258 / 102	Phase 1 current demand	A	V	V	V
260 / 104	Phase 2 current demand	A	V	V	X
262 / 106	Phase 3 current demand	A	V	V	X
264 / 108	Maximum phase 1 current demand	A	V	V	V
266 / 10A	Maximum phase 2 current demand	A	V	V	X
268 / 10C	Maximum phase 3 current demand	A	V	V	X
334 / 14E	Line 1 to line 2 volts THD	%	V	V	X
336 / 150	Line 2 to line 3 volts THD	%	V	V	X
338 / 152	Line 3 to line 1 volts THD	%	V	V	X
340 / 154	Average line to line volts THD	%	V	V	X
342 / 156	Total active energy	kWh	V	V	V
344 / 158	Total reactive energy	kVarh	V	V	V

## Notes:

1. The power factor has its sign adjusted to indicate the nature of the load. Positive for capacitive and negative for inductive.
2. The power sum demand calculation is for import power only.

## 9.2. Setup registers

Holding registers are used to store and display instrument configuration settings. All holding registers not listed in the table below should be considered as reserved for manufacturer use and no attempt should be made to modify their values. The holding register parameters may be viewed or changed using the Modbus Protocol. Each parameter is held in two consecutive 4X registers. Modbus Protocol Function Code 03 is used to read the parameter and Function Code 16 is used to write. Write to only one parameter per message. Write to only one parameter per message.

Register Address (Dec/Hex)	Parameter	Description	Mode
0 / 00	Demand Time	Read minutes into first demand calculation. When the Demand Time reaches the Demand Period then the demand values are valid.	r
2 / 02	Demand Period	Write demand period: 0, 5, 8, 10, 15, 20, 30 or 60 minutes, default 60. Setting the period to 0 will cause the demand to show the current parameter value, and demand max to show the maximum parameter value since last demand reset.	r/w
10 / 0A	System Type	Write system type: 3p4w = 3, 3p3w = 2 & 1p2w = 1 Requires password, see parameter 13	r/wp
12 / 0C	Relay pulse width	Write relay on period in milliseconds: 60, 100 or 200, default 200.	r/w
18 / 12	Network parity stop	Write the network port parity/stop bits for MODBUS Protocol, where: 0 = One stop bit and no parity, default. 1 = One stop bit and even parity. 2 = One stop bit and odd parity. 3 = Two stop bits and no parity. Requires a restart to become effective.	r/w



20 / 14	Network node	Write the network port node address: 1 to 247 for MODBUS Protocol, default 1. Requires a restart to become effective.	r/w
22 / 16	Pulsing output no. 1 Number of pulse	Write to register selecting value below: 1--0.01 kwh/pulse 2--0.1 kwh/pulse 3--1 kwh/pulse 4--10 kwh/pulse 5--100 kwh/pulse	r/w
28 / 1C	Network Baud rate	Write the network port baud rate for MODBUS Protocol, where: 0 = 2400 baud. 1 = 4800 baud. 2 = 9600 baud, default. 3 = 19200 baud. 4 = 38400 baud. Requires a restart to become effective	r/w
42 / 2A	Serial number	Read the product serial number.	r