

**HORUS**<sup>®</sup>  
PHOTOVOLTAIC  
PROTECTION



# PHOTOVOLTAIC

FUSE LINKS & FUSE HOLDERS FOR PHOTOVOLTAIC APPLICATIONS

## PMX 1100V DC

PV fuse holder  
for cylindrical fuse links

PMX

14x51



10x38



14x51



22x65

**PROTECTING  
THE WORLD**





<b>RATED CURRENT</b> 50A
<b>RATED VOLTAGE</b> 690V AC 1100V DC
<b>MAXIMUM POWER DISSIPATION</b> 6W
<b>PROTECTION INDEX</b> IP20
<b>STANDARDS</b> IEC/EN 60269-1 IEC/EN 60269-2 UL 4248-1 UL 4248-19 UL 486E



## Modular fuse holders that offer 1100V DC rated voltages

Modular fuse holder for cylindrical fuse link size 14x51 according IEC/EN 60269 standard.

Compact design, with reduced dimensions.

Ventilation zones optimized for a better heat dissipation.

Manufactured with a high quality materials

- Silver plated copper contacts.
- Plastic materials with high temperature resistance and self-extinguishable.
- All the materials are according to the European Directive RoHS.



Extended range of accessories is available.

## Accessories

REFERENCE	DESCRIPTION	PACKING Uni /BOX
<b>480005</b>	PINS FOR MULTIPOLE ASSEMBLY	12
<b>485356</b>	PMX-14/22 HANDLE TIES FOR MULTIPOLE ASSEMBLY	12
<b>485258</b>	PMX-14 LOCK SUPPORT	5
<b>485266</b>	SPECIAL IP20 PROTECTION ACCESSORY PMX-14	12
<b>485656</b>	SCREW'S PROTECTION ACCESSORY	12
<b>485271</b>	PMX-14 SPECIAL ACCESSORY SCREW CONNECTION	12

## Range

REFERENCE	INDICATOR	POLES	MODULES	PACKING Uni /BOX
<b>485250</b>	–	1P	1	6/90
<b>485251</b>	–	2P	2	3/45
<b>485252</b>	•	1P	1	6/90
<b>485253</b>	•	2P	2	3/45



## Technical data

Rated current	50A
Rated voltage	690V AC 1100V DC
Maximum power dissipation	6W
Power dissipation per pole	80% $I_n > 0,52W$ 100% $I_n > 0,88W$
Utilization category as per EN 60947-3	690V > AC-21B 1100V DC > DC-20B
Pollution degree	3
Protection index *	IP20
Rated insulation voltage	6kV U imp
Ambient temperature of service	-20°C ... 70°C
Storage temperature	-40°C ... 80°C

Derating by number of poles	POLES	$I_{MAX}$
	1 ... 4	$I_n$
	5 ... 6	$0,8 \times I_n$
	7 ... 9	$0,7 \times I_n$
	$\geq 10$	$0,6 \times I_n$

Correction of the admissible current in function of the temperature	Temperature	Factor
	20° C	1
	30° C	0,95
	40° C	0,90
	50° C	0,80
	60° C	0,70
	70° C	0,60

\* For wires of section  $\leq 10\text{mm}^2$  is necessary the use of the accessory to guarantee IP20 in clamps zone. ► **FIG. 4**

## Dimensions

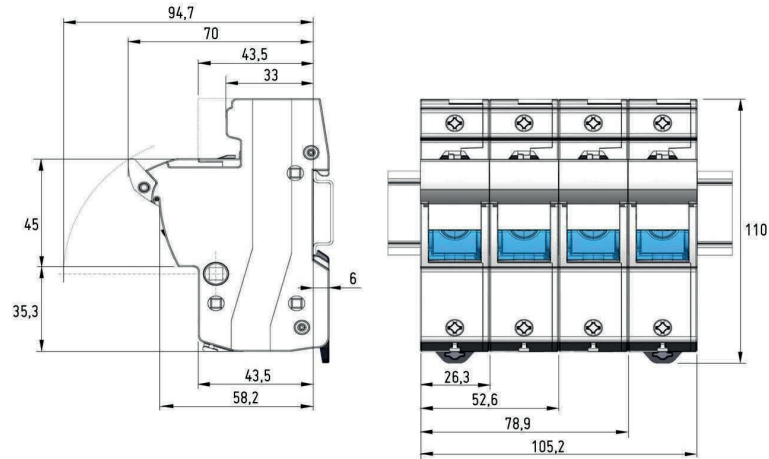

## Weight

<b>1P</b>	101gr
<b>2P</b>	202gr

Weight without packing

## Standards

- IEC/EN 60269-1
- IEC/EN 60269-2
- UL4248-1 Fuse holders
- UL4248-19 Photovoltaic fuse holders
- UL486E Wiring terminals



## Application characteristics

For mounting on DIN/EN standard rail

DIN 46277/1-3 (EN50022)  
Clip fixation with 2 positions

Connecting wire  
Copper wires only

WIRES	METRIC	AWG	WIRING
1	1,5...35mm <sup>2</sup> Solid	8....16 AWG Solid	
	1,5...25mm <sup>2</sup> Stranded	6....16 AWG Stranded	
2 Same cross section and type	1,5...16mm <sup>2</sup> Solid	6....16 AWG Solid / Stranded	
	1,5...10mm <sup>2</sup> Stranded		

### Wire-end terminals

The use of wire-end terminals may allow to increase the connecting wire section.

Wire-end terminals recommended mounting:

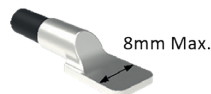

The use of wire-end terminals could not guarantee the IP20 protection degree.

### Ferrules

It's recommended use of ferrules in wires with section  $\leq 2,5\text{mm}^2$



The product is delivered with the terminals opened and ready to connect

## Accessories

FIG. 1 | Multipolar assembly

Standard system by DF, 3 clips and 1 pin for each union between poles

- 480005** PINS FOR MULTIPOLE ASSEMBLY
- 485356** PMX-14/22 HANDLE TIES FOR MULTIPOLE ASSEMBLY

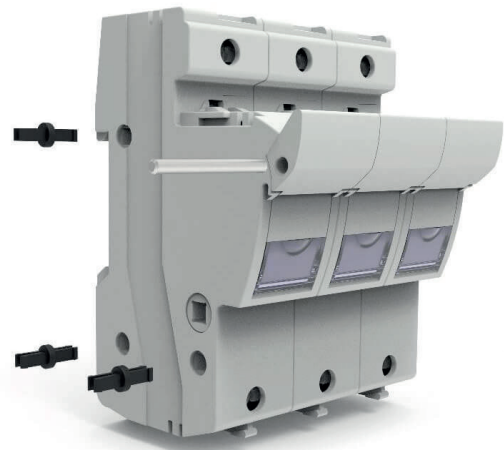
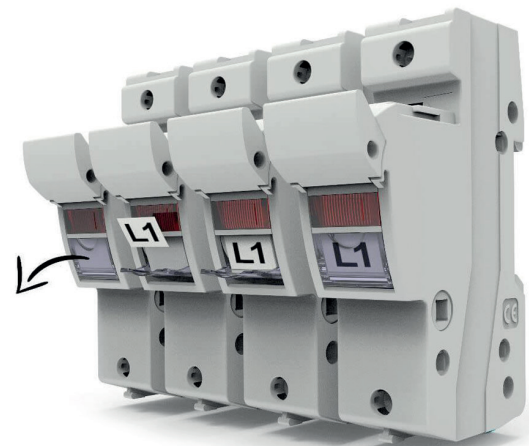

FIG. 2 | Identification by label

Open the label holder part when the fuseholder is totally closed or totally open, put on the label and close



Label measures **16x10mm**

**Tightening torque on terminals** 2,5...3 Nm / 22...27 lb.in

**Screws with a combined head** SLOT + PZ2

**Multipolar assembly** ► FIG. 1

**Fuse holders with fuse indicator** NEON VERSION  
350...1100V DC

**Label holder for a better circuit identification** ► FIG. 2  
Suitable size for label: 16x10 mm

**Special zone for sealing** 1,5 mm<sup>2</sup> wire

**Accessory available to lock the fuse holder by a padlock** ► FIG. 3  
(máx. 3 padlocks of Ø 3mm)



## Accessories

**FIG. 3 | Locking means a padlock**

To avoid the operation and connection when the fuse holder is open, put on the accessory "Padlock support" sliding it for the guides, and covering the fuse link zone. (Is possible the use with or without fuse link)

Introduce the padlock trough the symmetrical holes and close it

**485258** PMX-14 LOCK SUPPORT

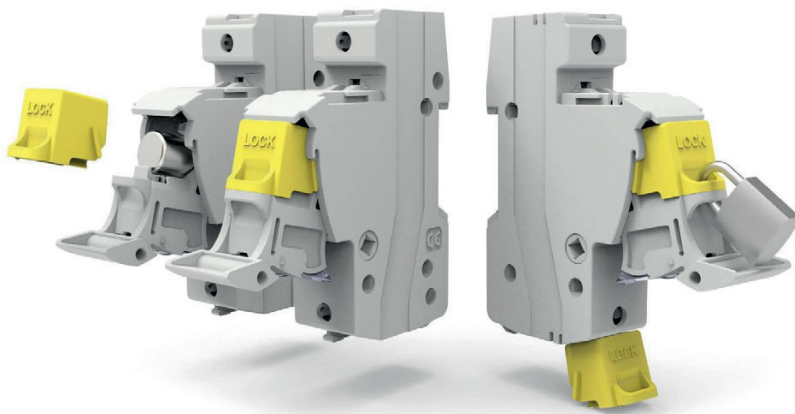

**FIG. 4 | Special IP20 protection**

The accessory must be positioned in the wire entries, if it's necessary to achieve the IP20 degree of protection with thin wires

**485266** SPECIAL IP20 PROTECTION ACCESSORY

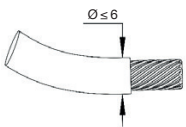

To obtain an IP20 rating with cable protection of  $\varnothing \le 6$ mm, use the special protection accessory

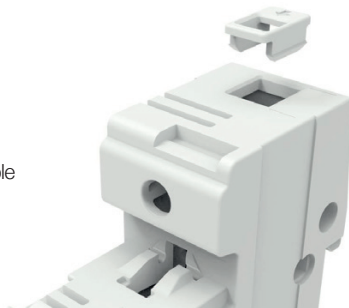

**FIG. 5 | PMX-14 Special accessory screw connection**

**485271** PMX-14 SPECIAL ACCESSORY SCREW CONNECTION

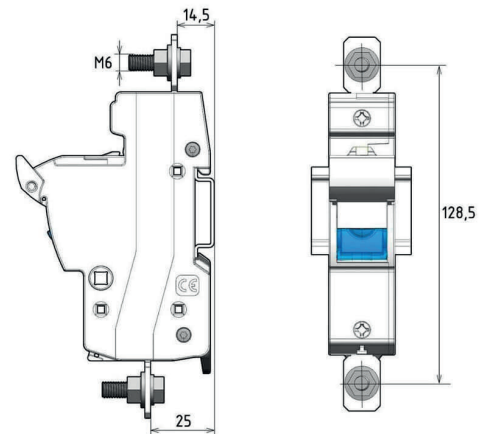
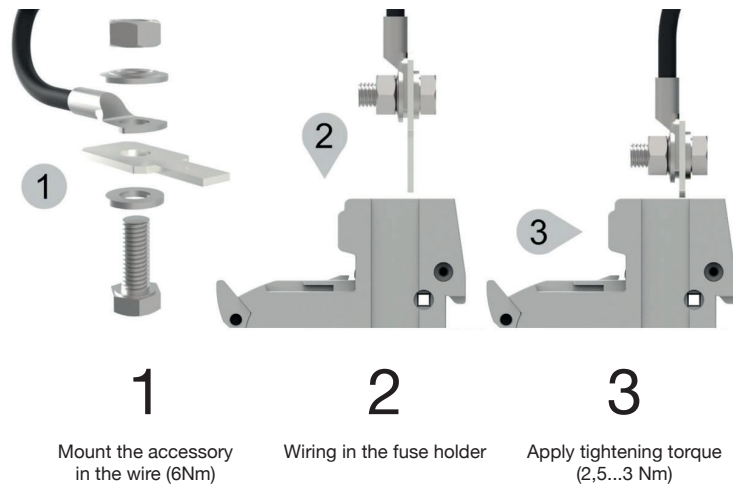



## Accessories

FIG. 6 | Fusing indicator replacement instructions

1

Open the fuse holder

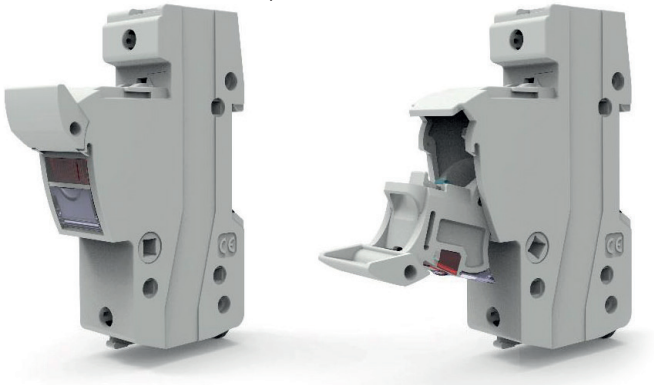

2

Using a flat screwdriver, remove the cover with a slight rotation of the tool

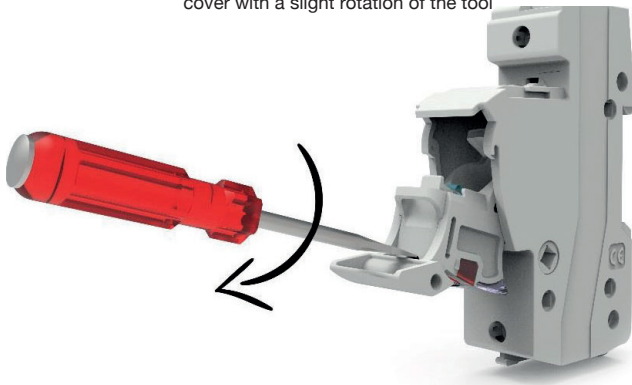

3

Replace the fusing indicator and enter the cover on the handle

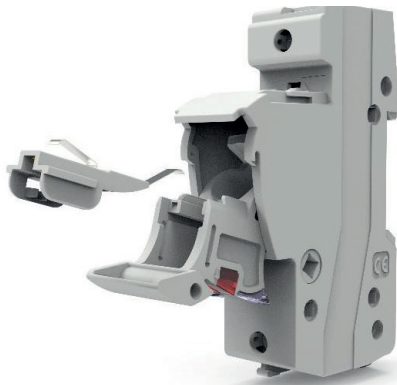

FIG. 7 | Screw's protection accessory

Protection accessory to avoid the screws manipulation and improve the protection degree

485656

SCREW'S PROTECTION ACCESSORY



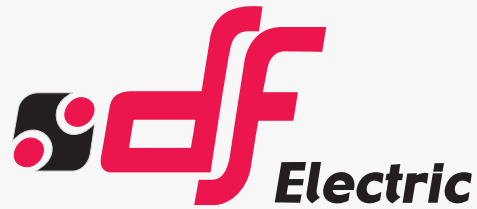

# PROTECTING THE WORLD



### HEAD OFFICE AND FACTORY

SILICI, 67-69  
08940 CORNELLA DE LLOBREGAT  
BARCELONA · SPAIN  
Tel. +34 93 377 85 85  
Fax +34 93 377 82 82

### INTERNATIONAL SALES

Tel. +34 93 475 08 64  
Fax +34 93 480 07 75  
export@dfelectric.es

### NATIONAL SALES

Tel. 93 475 08 64  
Fax 93 480 07 76  
comercial@dfelectric.es

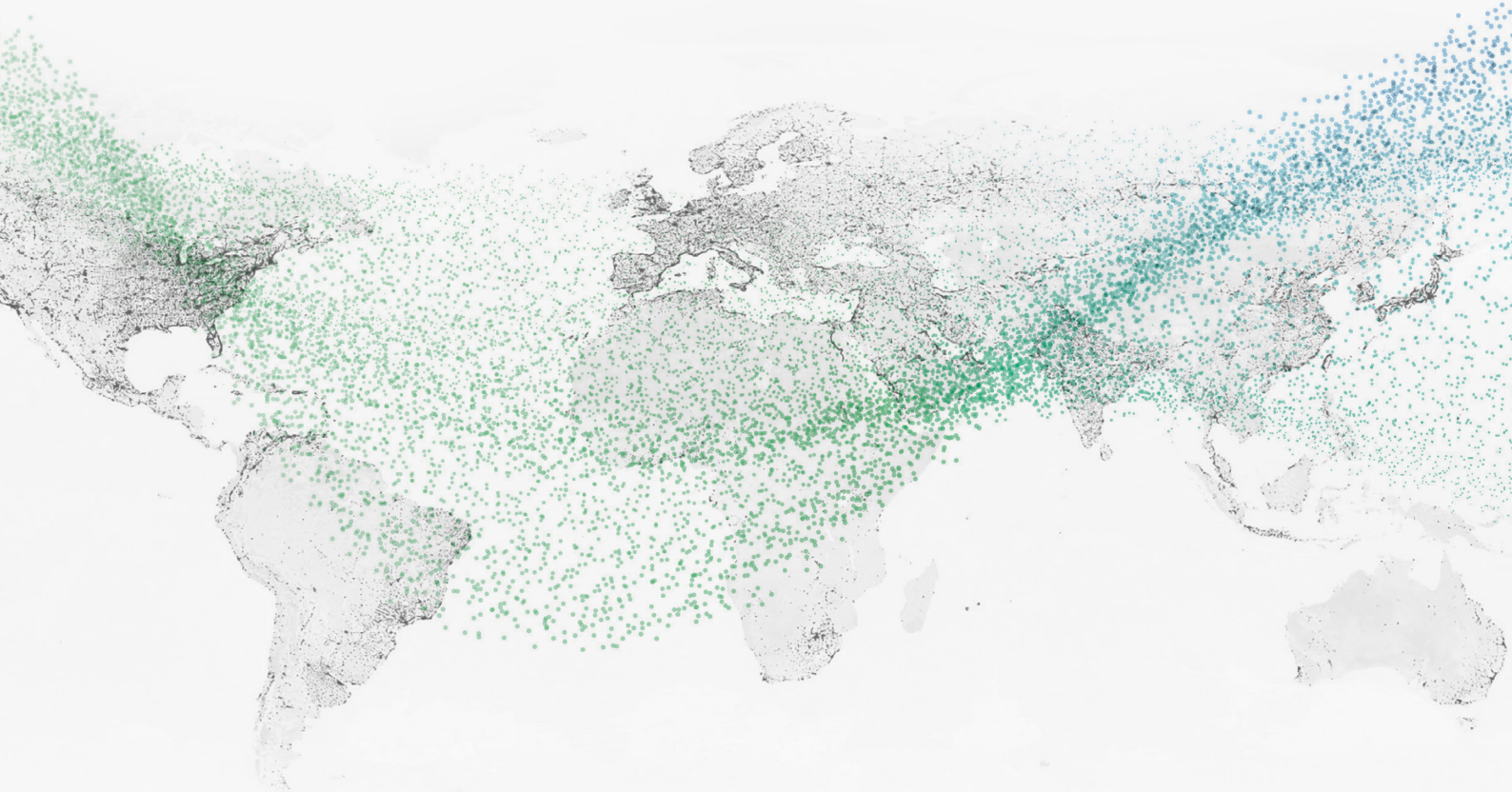

dfelectric.es



According to the waste of electrical and electronic equipment directive, electrical material should not be part of the usual waste. This symbol alerts users that these products should be recycled according to local environmental waste disposal regulations.



The "electro technical expert" logo marked on the products included in this data sheet indicates that the installation of these products must be carried out by expert personnel with specialized knowledge.



To prevent electrical hazards, carry out the installation without voltage.



#### Safety notice

Please capture the following QR code and read our safety notice carefully before installing our products.



The data reflected in this technical record are subject to the correct installation of the product in accordance with manufacturer's instructions, relevant installation standards and professional practices, maintained and used in applications for which they were made.

The products described in this document have been designed, developed and tested in accordance with specific standard. They are considered components that are integrated as part of installation, machine or equipment. The correct general operation of the referred product is responsibility of the manufacturer of the installation, machine or equipment.

DF ELECTRIC cannot guarantee the characteristics of an installation, machine or equipment that has been designed by a third party. Once a product has been selected, the user must verify that it is appropriate for its application, through the verifications and/or tests that it deems appropriate.

DF ELECTRIC retains the right to change the dimensions, specifications, materials or design of its products at any time with or without notice.