

RPC-.MD-UNI

time relays

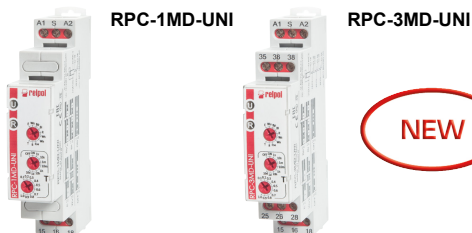

- **Immediate activation of the selected function**
- without having to temporarily turn off the power supply

- **Multifunction time relays (10 time functions; 8 time ranges)**
- Cadmium - free contacts 1 CO and 3 CO • AC/DC input voltages
- Cover - modular, width 17,5 mm • Direct mounting on 35 mm rail mount acc. to EN 60715 • Applications: in low-voltage systems
- Compliance with standard EN 61812-1
- Recognitions, certifications, directives: RoHS, **CE** **EMC**

Output circuit - contact data

Number and type of contacts	1 CO	3 CO
Contact material	AgSnO ₂	
Max. switching voltage	AC 300 V	
Rated load	AC1	8 A / 250 V AC
	DC1	8 A / 24 V DC
	DC1	0,3 A / 250 V DC
Rated current	16 A / 250 V AC	
Max. breaking capacity	AC1	2 000 VA
Min. breaking capacity	1 W 10 mA	
Contact resistance	≤ 100 mΩ	
Max. operating frequency	600 cycles/hour at rated load AC1	
Input circuit		
Rated voltage	AC: 50/60 Hz AC/DC 12...240 V terminals (+)A1, (-)A2	
Must release voltage	≥ 0,1 U _n	
Operating range of supply voltage	0,9...1,1 U _n	
Rated power consumption	AC	≤ 1,5 VA AC: 50 Hz
	DC	≤ 1,5 W
Range of supply frequency	AC 48...63 Hz	
Control contact S	• min. voltage ② 0,7 U _n	
	• min. time of pulse duration ②	AC: ≥ 50 ms DC: ≥ 30 ms
	• max. length of control line	10 m
Insulation according to EN 60664-1		
Insulation rated voltage	250 V AC	
Rated surge voltage	4 000 V 1,2 / 50 μs	
Overvoltage category	III	
Insulation pollution degree	2	
Flammability class	cover: V-0	front panel: V-2 UL 94
Dielectric strength	• input - output	4 000 V AC type of insulation: basic
	• contact clearance	1 000 V AC type of clearance: micro-disconnection
	• pole - pole	2 000 V AC contacts 3 CO, type of insulation: basic
General data		
Electrical life	• resistive AC1	> 0,5 x 10 ⁵ 16 A, 8 A, 250 V AC
Mechanical life (cycles)	> 3 x 10 ⁷	
Dimensions (L x W x H)	90 ④ x 17,5 x 64,5 mm	
Weight	contact 1 CO: 65 g	contacts 3 CO: 88 g
Ambient temperature	• storage	-40...+70 °C
(non-condensation and/or icing)	• operating	-20...+50 °C
Cover protection category	IP 20	EN 60529
Relative humidity	up to 85%	
Shock / vibration resistance	15 g / 0,35 mm DA 10...55 Hz	
Time module data		
Functions	E, Wu, Bp, Bi, R, Ws, Wa, Esa, B, T	
Time ranges	OFF - permanent switching off; ON - permanent switching on 1 s ⑤; 10 s; 1 min.; 10 min.; 1 h; 10 h; 1 d; 10 d	
Timing adjustment	smooth - (0,1...1) x time range (does not refer to range ON / OFF)	
Setting accuracy / Repeatability	± 5% ⑥ ④ / ± 0,5% ④	
Values affecting the timing adjustment	temperature: ± 0,05% / °C	supply voltage: ± 0,01% / V
Recovery time	AC: ≤ 400 ms	DC: ≤ 150 ms
LED indicator	green LED U ON - indication of supply voltage U green LED U flashing - measurement of T time yellow LED R ON/OFF - output relay status	

① The control terminal S is activated by connection to A1 terminal via the external control contact S. ② Where the control signal is recognizable.
③ Length with 35 mm rail catches: 98,8 mm. ④ For first range setpoint (1 s) setting accuracy and repeatability are smaller than the given ones in technical parameters (significant influence of the operational relay operating time, processor start-time, and the moment of supply switching as referred to the AC supply course). ⑤ Calculated from the final range values, for the setting direction from minimum to maximum.

Time functions

E - ON delay.

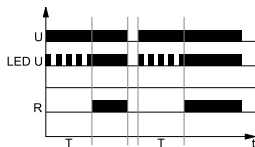

On applying the supply voltage U the set interval T begins - off-delay of the output relay R. After the interval T has lapsed, the output relay R switches on and remains on until supply voltage U is interrupted.

Wu - ON for the set interval.

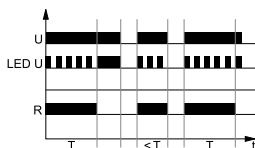

Applying the supply voltage U immediately switches the output relay R on for the set interval T. After the interval T has lapsed, the output relay R switches off.

Bp - Symmetrical cyclical operation pause first.

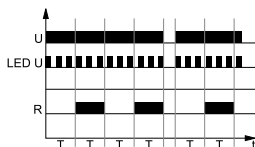

Applying the supply voltage U starts the cyclical operation from the interval T - switching the output relay R off followed by switching on the output relay R for the interval T. The cyclical operation lasts until the supply voltage U is interrupted.

Bi - Symmetrical cyclical operation pulse first.

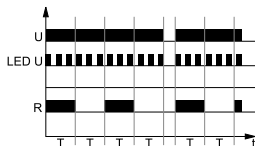

Applying the supply voltage U starts the cyclical operation from switching on the output relay R for the set interval T. After the interval T has lapsed, the output relay R switches off for the interval T. The cyclical operation lasts until the supply voltage U is interrupted.

R - OFF delay with the control contact S.

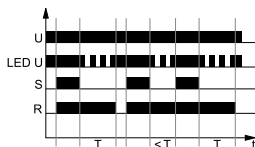

The input of the time relay is supplied with voltage U continuously. Closing of the control contact S immediately switches on the output relay R. Opening of the control contact S starts the set time of the delayed switching off of the output relay R. After the interval T has lapsed, the output relay R switches off. If the control contact S is closed during the interval T, the already measured time is reset, and the output relay R is switched on again. The OFF delay of the output relay R will start when the control contact S is opened again.

Ws - Single shot for the set interval triggered by closing of the control contact S.



The input of the time relay is supplied with voltage U continuously. Closing of the control contact S immediately switches the output relay R on for the set interval T. After the interval T has lapsed, the output relay R is switched off. In the course of the interval T, any opening of the control contact S does not affect the function to be performed. The output relay R may be switched on again for the set interval, after the interval T has lapsed, by closing the control contact S again.

Wa - ON for the set interval triggered with the control contact S.

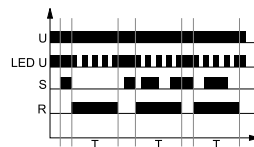

The input of the time relay is supplied with voltage U continuously. Closing of the control contact S does not start the interval T, and it does not change the position of the output relay R. Opening of the control contact S immediately switches on the output relay R for the set time. After the interval T has lapsed, the output relay R switches off. Opening and closing of the control contact S in the course of the interval T does not affect the function to be performed. The output relay R may be switched on again for the set interval with another closing and opening of the control contact S.

Esa - ON and OFF delay with the control contact S.

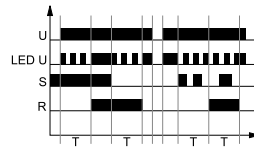

The input of the time relay is supplied with voltage U continuously. Closing of the control contact S starts the interval T - on-delay of the output relay R. After the interval T has lapsed, the output relay R switches on. Opening of the control contact S begins further measurement of the interval T - off-delay of the output relay R, and after the interval has lapsed, the output relay switches off. In case the time for which the control contact S is closed in the course of measurement of the on-delay of the output relay R is shorter than the set interval T, the output relay R will switch on after the set interval T, and the output relay R will remain in on position for the interval T. When the output relay R is in on position, closing of the control contact S does not affect the function to be performed.

U - supply voltage; R - output state of the relay; S - control contact state; T - measured time; t - time axis

Time functions

B - Cyclical operation controlled with closing of the control contact S.

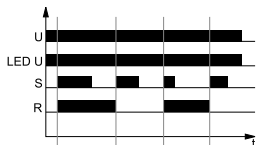

The input of the time relay is supplied with U voltage continuously. Closing of the control contact S immediately switches on the output relay R. Each next closing of the control contact S results in a change of the status of the output relay R to an opposite one (the feature of a bistable relay).

U - supply voltage; **R** - output state of the relay; **S** - control contact state; **T** - measured time; **t** - time axis

T - Generation of the 0,5 s pulse after the interval T.

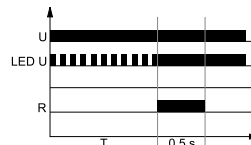

Applying the supply voltage U starts the interval T. After the interval T has lapsed, the output relay switches on for 0,5 s (the time of the NO contact of the output relay).

ON / OFF - Permanent switching on / off.

The functions ON and OFF are selected with T time range adjusting knob. In the ON function, the normally open contacts are closed all the time whereas in the OFF function they are open. The position of the function-adjusting knob is of no significance in these functions as is the preset measurement time. The ON or OFF functions are used for the time relay operation control in electric systems.

Additional functions

Supply diode: it is lit permanently when the time is not being measured. In course of the T time measurement, it flashes at 500 ms period where it is lit for 50% of the time, and off for 50% of the time.

Adjustment of the set values:

- the values of time and range are read in the course of the relay's operation. The set values may be modified at any moment,
- it is possible to change the function during operation of the relay, which results in triggering operation with a new setting. It is not necessary to switch the supply off and on again for the relay to start operating with a new setting.

Release: depending on the function to be performed, the relay is released with the supply voltage or by connection of the S contact to the A1 line. For DC supply, the positive pole must be connected to the A1 line. The level of the S contact activation is adjusted automatically depending on the supply voltage.

Supply: the relay may be supplied with DC voltage or AC voltage 48...63 Hz of 10,8...264 V.

Dimensions

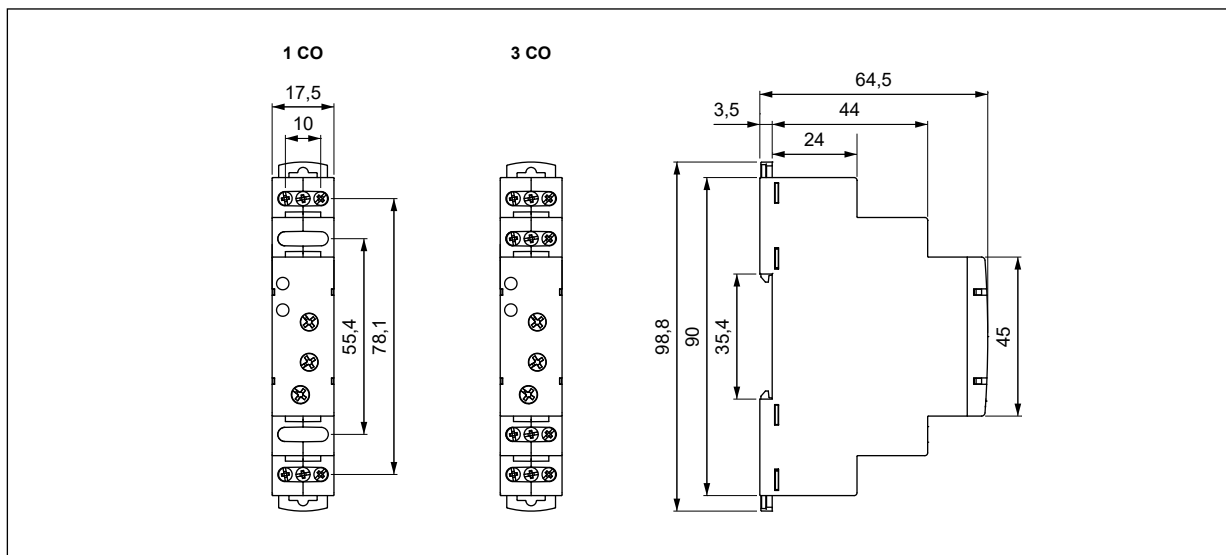

PRECAUTIONS:

1. Ensure that the parameters of the product described in its specification provide a safety margin for the appropriate operation of the device or system and never use the product in circumstances which exceed the parameters of the product. 2. Never touch any live parts of the device. 3. Ensure that the product has been connected correctly. An incorrect connection may cause malfunction, excessive heating or risk of fire. 4. In case of any risk of any serious material loss or death or injuries of humans or animals, the devices or systems shall be designed so to equip them with double safety system to guarantee their reliable operation.

RPC-.MD-UNI

time relays

Front panel description

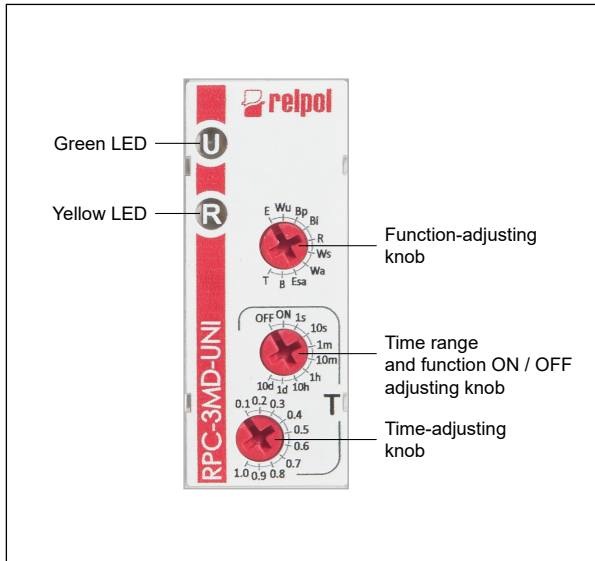

Connection diagrams

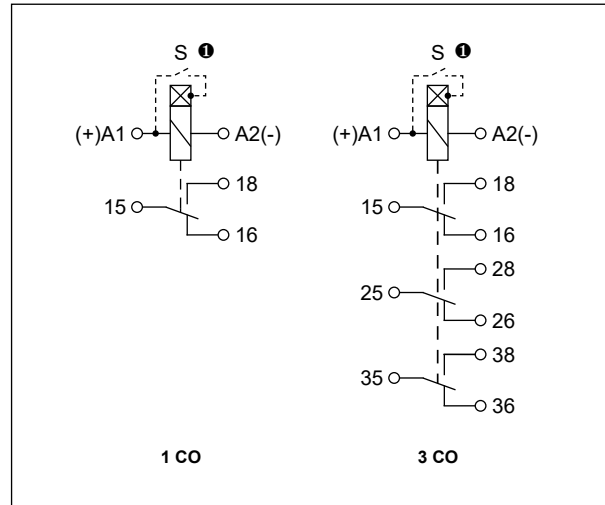

① The control terminal S is activated by connection to A1 terminal via the external control contact S.

Mounting

Relays **RPC-.MD-UNI** are designed for direct mounting on 35 mm rail mount acc. to EN 60715. Operational position - any. **Connections:** max. cross section of the cables: 1 x 2,5 mm² (1 x 14 AWG), stripping length: 6,5 mm, max. tightening moment for the terminal: 0,5 Nm.



Two catches:
easy mounting
on 35 mm rail,
firm hold
(top and bottom).



**Mounting wires
in clamps:**
universal screw
(cross-recessed
or slotted head).

Ordering codes

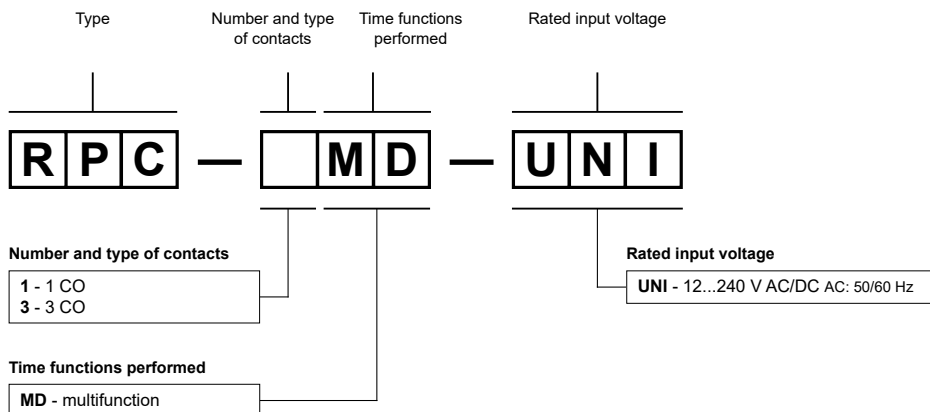

Examples of ordering codes:

RPC-1MD-UNI

time relay **RPC-.MD-UNI**, multifunction (relay perform 10 functions), cover - modular, width 17,5 mm, one changeover contact, contact material AgSnO₂, rated input voltage 12...240 V AC/DC AC: 50/60 Hz

RPC-3MD-UNI

time relay **RPC-.MD-UNI**, multifunction (relay perform 10 functions), cover - modular, width 17,5 mm, three changeover contacts, contact material AgSnO₂, rated input voltage 12...240 V AC/DC AC: 50/60 Hz