

HD1 Series

AC Variable Speed Inverter Drives

DUAL RATED

IMO

Technical Datasheet

3 Phase 200/240V 50/60Hz **0.75~55kW**

3 Phase 380/460V 50/60Hz **1.5~500kW**

3 Phase 575/600V 50/60Hz **18.5~110kW**

- Dual rated for HD & ND applications
- Torque Vector control
- Up to 150% starting torque
- Permanent magnet motor control
- Detachable keypad with copy
- Advanced LCD keypad
- IP20 (full range)
- High speed processor
- Modbus RTU/RS485 built in
- Profibus DP card
- CANopen card
- Profinet card
- 9 Digital Inputs
- 3 Analogue Inputs
- 2 Analogue Outputs
- 2 Relay Outputs
- Motor Auto-tune (static and dynamic)
- 2 motor parameter sets
- DC Injection braking
- Flux braking
- Integral brake chopper (<30kW)
- Braking units 37kW & above
- PID Control as standard
- Integral PLC function
- Integral C3 filter
- Category C1 & C2 filter options
- UL/cUL, TUV
- CE Marked
- 2 Year warranty



Ordering Information

Series		HD1 - 75A - 43		Input 400V Three Phase	
HD1 Inverter Drive		HD1			
Output Power kW (HP)					
1.5kW (2HP)	3.7A	30kW (40HP)	60A	185kW (250HP)	340A
2.2kW (3HP)	5A	37kW (50HP)	75A	200kW (270HP)	380A
4.0kW (5.5HP)	9.5A	45kW (60HP)	92A	220kW (300HP)	425A
5.5kW (7.5HP)	14A	55kW (75HP)	115A	250kW (335HP)	480A
7.5kW (10HP)	18.5A	75kW (90HP)	150A	280kW (375HP)	530A
11kW (15HP)	25A	90kW (125HP)	180A	315kW (420HP)	600A
15kW (20HP)	32A	110kW (150HP)	215A	350kW (470HP)	650A
18.5kW (25HP)	38A	132kW (175HP)	260A	400kW (535HP)	720A
22kW (30HP)	45A	160kW (215HP)	305A	500kW (670HP)	860A

Series		HD1 - 130A - 23		Input 200V Three Phase	
HD1 Inverter Drive		HD1			
Output Power kW (HP)					
0.75kW (1HP)	4.5A	15kW (20HP)	55A		
1.5kW (2HP)	7A	18.5kW (25HP)	70A		
2.2kW (3HP)	10A	22kW (30HP)	80A		
4kW (5.5HP)	16A	30kW (40HP)	110A		
5.5kW (7.5HP)	20A	37kW (50HP)	130A		
7.5kW (10HP)	30A	45kW (60HP)	160A		
11kW (15HP)	42A	55kW (75HP)	200A		

Series		HD1 - 52A - 63		Input 600V Three Phase	
HD1 Inverter Drive		HD1			
Output Power kW (HP)					
18.5kW (25HP)	27A	55kW (75HP)	86A		
22kW (30HP)	35A	75kW (90HP)	98A		
30kW (40HP)	45A	90kW (125HP)	120A		
37kW (50HP)	52A	110kW (150HP)	150A		
45kW (60HP)	62A				

HD1 Series

AC Variable Speed Inverter Drives



Technical Datasheet

Ordering Information for Accessories

Model	Description
HD1-E-PDP	Profibus option card
HD1-E-COP	CANopen option card
HD1-E-PRF	PROFinet option card
HD1-KP-LED	HD LED Keypad (std)
HD1-KP-LCD	HD LCD Keypad
DBU22/37-4	Dynamic brake unit, 22-37kW / 400V
DBU45/75-4	Dynamic brake unit, 45-75kW / 400V
DBU90/110-4	Dynamic brake unit, 90-110kW / 400V
DBU132-4	Dynamic brake unit, 132kW / 400V
DBU160/200-4	Dynamic brake unit, 160-200kW / 400V
DBU220/250-4	Dynamic brake unit, 220-250kW / 400V

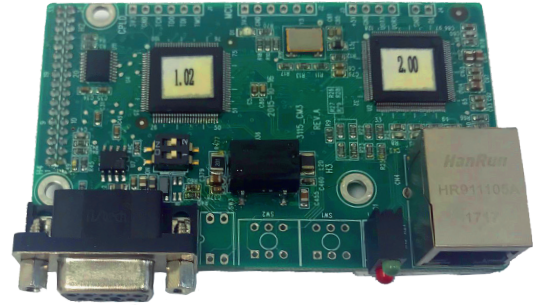

HD1-E-COP

Technical Specifications

Model	HD Mode (150% Overload - 1 min)				ND Mode (120% Overload - 1 min)			
	Rated Power kW (HP)	Carrier Frequency (kHz)	Rated Input Current (A)	Rated Output Current (A)	Rated Power kW (HP)	Carrier Frequency (kHz)	Rated Input Current (A)	Rated Output Current (A)
HD1-3.7A-43	1.5 (2)	8	5	3.7	-	-	-	-
HD1-5A-43	2.2 (3)	8	5.8	5	-	-	-	-
HD1-9.5A-43	4 (5.5)	8	13.5	9.5	5.5 (7.5)	4	19.5	14
HD1-14A-43	5.5 (7.5)	8	19.5	14	7.5 (10)	4	25	18.5
HD1-18.5A-43	7.5 (10)	8	25	18.5	11 (15)	4	32	25
HD1-25A-43	11 (15)	8	32	25	15 (20)	4	40	32
HD1-32A-43	15 (20)	4	40	32	18.5 (25)	2	47	38
HD1-38A-43	18.5 (25)	4	47	38	22 (30)	2	56	45
HD1-45A-43	22 (30)	4	56	45	30 (40)	2	70	60
HD1-60A-43	30 (40)	4	70	60	37 (50)	2	80	75
HD1-75A-43	37 (50)	4	80	75	45 (60)	2	94	92
HD1-92A-43	45 (60)	4	94	92	55 (75)	2	128	115
HD1-115A-43	55 (75)	4	128	115	75 (90)	2	160	150
HD1-150A-43	75 (90)	2	160	150	90 (125)	2	190	180
HD1-180A-43	90 (125)	2	190	180	110 (150)	2	225	215
HD1-215A-43	110 (150)	2	225	215	132 (175)	2	265	260
HD1-260A-43	132 (175)	2	265	260	160 (215)	2	310	305
HD1-305A-43	160 (215)	2	310	305	185 (250)	2	345	340
HD1-340A-43	185 (250)	2	345	340	200 (270)	2	385	380
HD1-380A-43	200 (270)	2	385	380	220 (300)	2	430	425
HD1-425A-43	220 (300)	2	430	425	250 (335)	2	485	480
HD1-480A-43	250 (335)	2	485	480	280 (375)	2	545	530
HD1-530A-43	280 (375)	2	545	530	315 (420)	2	610	600
HD1-600A-43	315 (420)	2	610	600	350 (470)	2	625	650
HD1-650A-43	350 (470)	2	625	650	400 (535)	2	715	720
HD1-720A-43	400 (535)	2	715	720	500 (670)	2	890	860
HD1-860A-43	500 (670)	2	890	860	-	-	-	-

Model	Output Power kW (HP)	Carrier Frequency (kHz)	Input Current (A)	Rated Output Current (A)
HD1-4.5A-23	0.75 (1)	2	5	4.5
HD1-7A-23	1.5 (2)	2	7.7	7
HD1-10A-23	2.2 (3)	2	11	10
HD1-16A-23	4 (5.5)	2	17	16
HD1-20A-23	5.5 (7.5)	2	21	20
HD1-30A-23	7.5 (10)	2	31	30
HD1-42A-23	11 (15)	2	43	42
HD1-55A-23	15 (20)	2	56	55
HD1-70A-23	18.5 (25)	2	71	70
HD1-80A-23	22 (30)	2	81	80
HD1-110A-23	30 (40)	2	112	110
HD1-130A-23	37 (50)	2	132	130
HD1-160A-23	45 (60)	2	163	160
HD1-200A-23	55 (75)	2	200	200

Model	Output Power kW (HP)	Carrier Frequency (kHz)	Input Current (A)	Rated Output Current (A)
HD1-27A-63	18.5 (25)	4	35	27
HD1-35A-63	22 (30)	4	40	35
HD1-45A-63	30 (40)	4	47	45
HD1-52A-63	37 (50)	4	52	52
HD1-62A-63	45 (60)	4	65	62
HD1-86A-63	55 (55)	4	85	86
HD1-98A-63	75 (90)	2	95	98
HD1-120A-63	90 (125)	2	118	120
HD1-150A-63	110 (150)	2	145	150

HD1 Series

AC Variable Speed Inverter Drives

Power & Control Connections

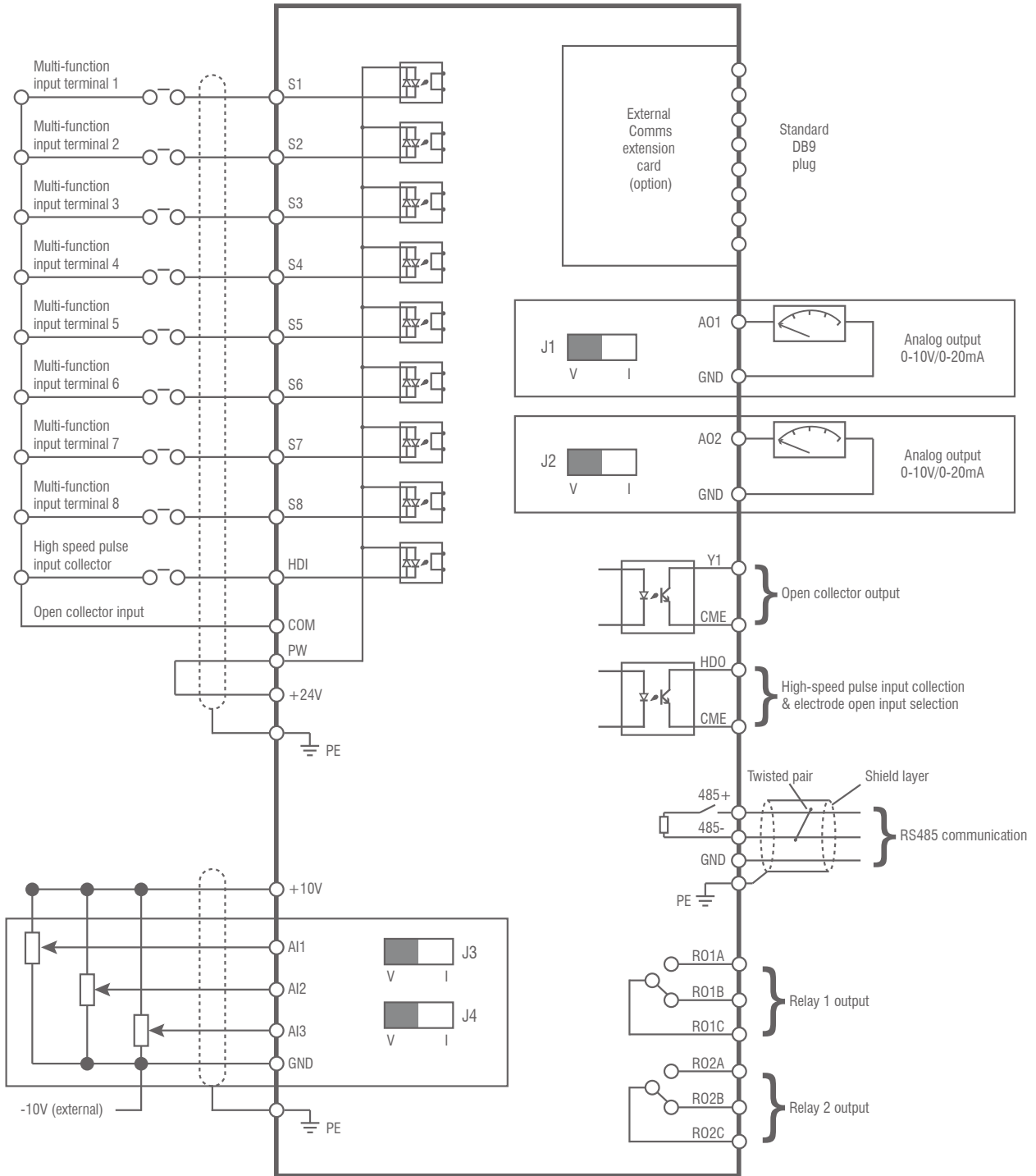

HD1 Series

AC Variable Speed Inverter Drives



Technical Datasheet

Dimensions (mm)

	Model	W1	W2	H1	H2	D1	Frame Style
200V	HD1-4.5A-23	126	115	193	175	174.5	A
	HD1-7A-43 to HD1-10A-23	146	131	263	243.5	181	
	HD1-16A-23 to HD1-20A-23	170	151	331.5	303.5	216	
	HD1-30A-23	230	210	342	311	216	
	HD1-42A-23 to HD1-55A-23	255	237	407	384	245	
	HD1-70A-23 to HD1-110A-23	270	130	555	540	325	B
HD1-130A-23 to HD1-200A-23	325	200	680	661	365		

	Model	W1	W2	H1	H2	D1	Frame Style
400V	HD1-3.7A-43 to HD1-5A-43	126	115	193	175	174.5	A
	HD1-9.5A-43 to HD1-14A-43	146	131	263	243.5	181	
	HD1-18.5A-43 to HD1-25A-43	170	151	331.5	303.5	216	
	HD1-32A-43 to HD1-38A-43	230	210	342	311	216	
	HD1-45A-43 to HD1-60A-43	255	237	407	384	245	
	HD1-75A-43 to HD115A-43	270	130	555	540	325	B
	HD1-150A-43 to HD1-215A-43	325	200	680	661	365	
	HD1-260A-43 to HD1-380A-43	500	180	870	850	360	
	HD1-425A-43 to HD1-600A-43	750	230	1410	1390	380	
HD1-650A-43 to HD1-860A-43	620	230	1700	1678	560	E	

	Model	W1	W2	H1	H2	D1	Frame Style
600V	HD1-27A-63 ~ HD1-35A-43	270	130	555	540	325	B
	HD1-45A-63 ~ HD1-150A-63	325	200	680	661	365	

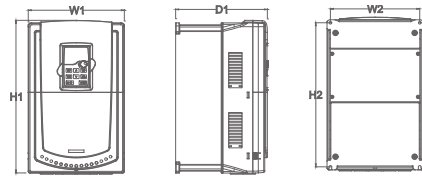

Frame Style A

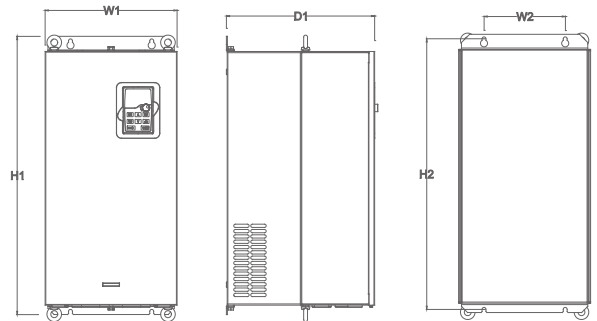

Frame Style B

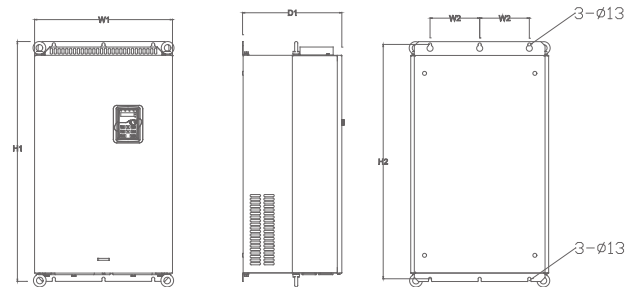

Frame Style C

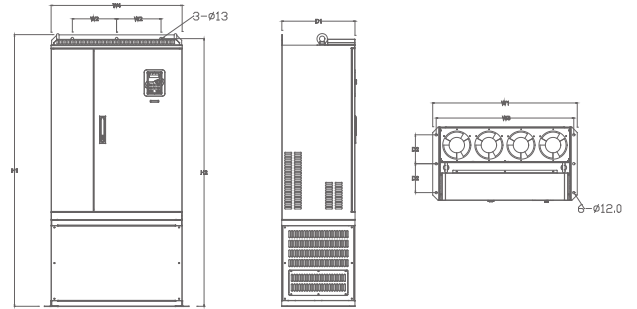

Frame Style D

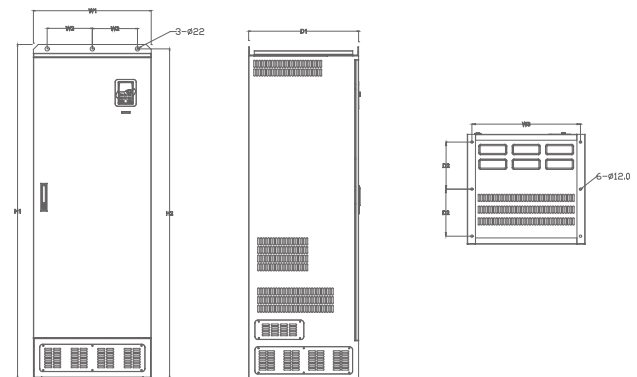

Frame Style E

HD1 Series Braking Units



Inverter	Braking Unit	Resistor at 100% of Braking Torque (Ω)	Consumed power of Braking Resistor			Min. allowable Braking Resistance (Ω)
			10% Braking	50% Braking	80% Braking	
37kW	DBU22/37-4	13.2	6	28	44	11.7
45kW	DBU45/75-4	10.9	7	34	54	4.4
55kW		8.9	8	41	66	
75kW		6.5	11	56	90	
90kW	DBU90/110-4	5.4	14	68	108	3.2
110kW		4.5	17	83	132	
132kW	DBU132-4	3.7	20	99	158	2.2
160kW	DBU160/200-4	3.1	24	120	192	1.8
200kW		2.5	30	150	240	
220kW	DBU220/250-4	2.2	33	165	264	2.2*2
250kW		2	38	188	300	
280kW	2x DBU160/200-4	3.6*2	21*2	105*2	168*2	1.8*2
315kW		3.2*2	24*2	118*2	189*2	
350kW		2.8*2	27*2	132*2	210*2	
400kW		2.4*2	30*2	150*2	240*2	
500kW	2x DBU220/250-4	2*2	38*2	186*2	300*2	1.8*2



Keypads

HD1-KP-LED



HD1-KP-LCD

