

DIN Timers TD



Technical Datasheet

Key Features

- 17.5mm or 22.5mm DIN Rail mounting Electronic Timers
- Wide coil operation, 12V to 320V AC/DC
- Multi time range / Multi function
- ON-Delay, OFF-Delay, Asymetrical, Star/Delta versions
- Perfect to fit in modular enclosure
- Protection against overvoltage and reverse polarity
- Self-extinguishing plastic housing



Options & Ordering Codes

	TD	M10
Series	DIN Rail Mount Timers	
	XX	
Timer Type		
Multi-function		M10
Multi-function 12VAC/DC		M10-12
Star/Delta 20-500ms		SD1
Asymetrical 5 function		AS

Specification

	TDM10-12	TDM10	TDAS	TSD1
Operation Modes	A, B, C, D, E, F, G, H, I, K		ND, FD, NFD, Fon, Foff	Star Delta
Time Range	0.1 sec - 10 days	0.1 sec - 10 days	0.1 sec - 10 days	λ1-30 sec / λ Δ20-500ms
Accuracy	30ppm			
Supply Voltage	12V AC/DC / 180-265V AC	24-300V AC/DC, ±10%, 45-65Hz		150-500V AC, 45-65Hz
Nominal Power Consumption	24-320V DC max 1W; 24V AC 2.5VA; 48V AC 4.46VA; 110V AC 1.76VA; 220V AC 2.53VA			
Input Signal Control Contact Must Be 90% of A1-A2	Power On - Contact Control		Power On	
Contact Configuration	1 C/O Contact		2 Independant C/O Contacts	
Control Output	10A @ 250V AC / 3A @ 30V DC			
Life Expectancy	Electrical	5 x 10 ⁴ (5A @ 250V AC),		
	Mechanical	10 ⁷ Operations		
Ambient Allowable Temperature	Storage	-40 to +85°C		
	Operating	-25 to +70°C		
IP Rating	IP20			
Terminals	2.5mm ² Stranded, 4mm ² Solid or 2x1.5mm ² Solid			
Warranty / Certification	2 Years / CE / UL / cUL			

DIN Timers TDM10 / TDM10-12



Key Features

- Multi function time delay
- Multi time range
- Compact design
- TDM10: Universal voltage input 24-300V AC/DC
- TDM10-12: Voltage input 12V AC/DC & 180-265V AC
- Single module size



Specification

	TDM10-12	TDM10
Adjustable Values / Time Range		1 second
		10 second
		100 second
		1 minute
		10 minute
		1 hour
		10 hour
		100 hour
		1 day
		10 day
Multiplier	0.1 - 0.2 - 0.3 - 0.4 - 0.5 - 0.6 - 0.7 - 0.8 - 0.9 - 1	

Dimensions (mm)

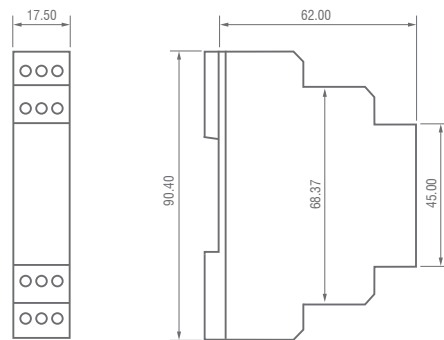

Indication Lights Legend

LED	State	Description
On / t	ON	Power On
	OFF	Power Off
Relay Output	ON	Output relay energised
	OFF	Output relay de-energised
M1, M2	M1, M2 are used to indicate which function is currently used. See charts page 3 for more details.	

Time Settings

Time range selector switch selects full scale time range. The t multiplier selector switch provides fine adjustment of time value, t, within the full scale time range. Selector switch positions are latched upon startup to avoid accidental changes during operation. Therefore changing selector switch positions have no effect when the device is operational. The below example shows how to set a t value.

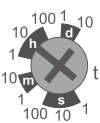

Time Range

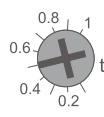

t Multiplier

In the above figure: $t = 10h \times 0.5 = 5 \text{ hour}$

Note: All the pot values are digitalised. Cannot be set to mid values.

Connections - TDM10

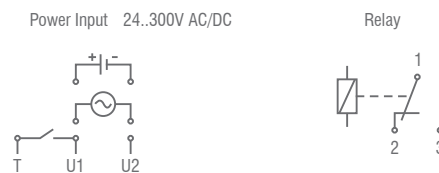

Connections - TDM10-12

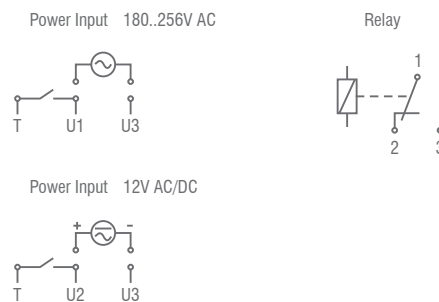

Mode Functions

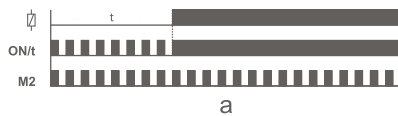

A On Delay

The output relay is initially de-energised after an adjustable time delay, t.

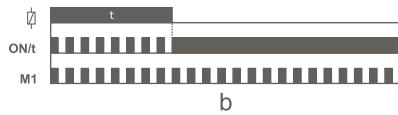

B Off Delay

The output relay is initially energised and de-energised after an adjustable time delay, t.

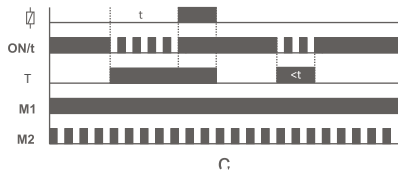

C On delay with control input

The output relay is initially de-energised. A contact closure on K input triggers an adjustable time delay, t, which energises the output relay when expired. The output relay stays energised as long as the K input is active. Delay time, t, is cleared when the contact on K input opens.

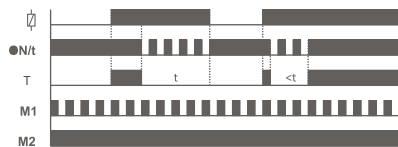

D Off delay with control input

The output relay is initially de-energised and energised when a contact closure on K input is detected. A contact release on K input triggers an adjustable time delay, t, which de-energises the output relay when expired. Reclosure of the contact on K input before the time delay is expired restarts time delay, t, and keeps the output relay energised.

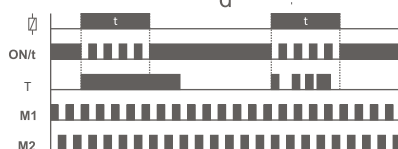

E Rising edge triggered Off delay

The output relay is initially de-energised. A contact closure on K input both energises the output relay and triggers an adjustable time delay, t, which de-energises the output relay when expired. During the time delay, K input is insensitive to state changes and becomes sensitive when time delay, t, expired.

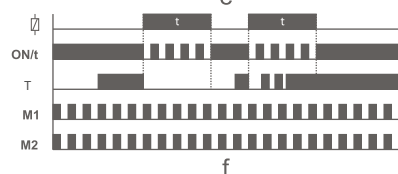

F Falling edge triggered Off delay

The output relay is initially de-energised. A state change of the contact on K input from closed to open both energises the output relay and triggers an adjustable time delay, t, which de-energises the output relay when expired. During the time delay, K input is insensitive to state changes and becomes sensitive when time delay t, expired.

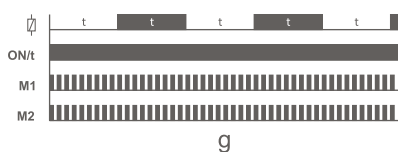

G Off flasher

The output relay is initially de-energised and energised after an adjustable time delay, t, and stays energised for the period, t, and the de-energised. This loop is repeated until the device is powered off.

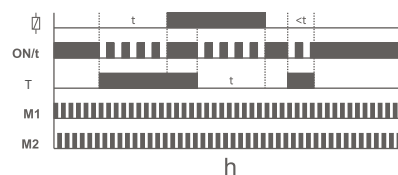

H On and Off delay with control input

The output relay is initially de-energised. A contact closure on K input triggers an adjustable time delay, t, which energises the output relay when expired. Similarly contact release of K input triggers the time delay, t, which de-energises the output relay when expired. Delay time, t, is cleared when the contact state of K input changes.

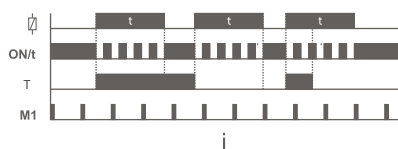

I Adjustable pulse output with control input

The output relay is initially de-energised. A state change on K input both energises the output relay and triggers an adjustable time delay, t, which de-energises the output relay when expired. During the time delay, K input is insensitive to state changes and becomes sensitive when time delay, t, expired.

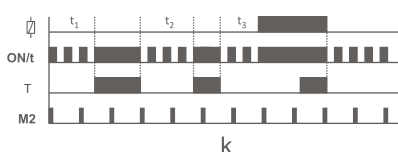

K On delay with memory

The output relay is initially de-energised. If K input is open, adjustable time delay, t, counts down and output relay energises when t is expired. Any contact closure on K input pauses the count down process, and the process continues when the contact release on K input occurs. A contact release is needed to restart the cycle, after the output relay is energised.

$$t = t_1 + t_2 + t_3$$

■ On
□ Off

DIN Timers TDAS

Key Features

- Asymmetrical DIN Timer
- Multi time range
- Compact design
- Universal voltage input 24-300V AC/DC
- Single module size



Specification

	TDAS
Adjustable Values / Time Range	1 second
	10 second
	100 second
	1 minute
	10 minute
	1 hour
	10 hour
	100 hour
	1 day
	10 day
Multiplier	0.1 - 0.2 - 0.3 - 0.4 - 0.5 - 0.6 - 0.7 - 0.8 - 0.9 - 1

Indication Lights Legend

LED	State	Description
On / t	ON	Power On
	OFF	Power Off
Relay Output	ON	Output relay energised
	OFF	Output relay de-energised
M1, M2	ON	On-Off delay mode
	M2 flashing, M1 off	On delay mode
	M1 flashing, M2 off	Off delay mode
	Flash sequentially	On flasher mode
	Flash simultaneously	Off flasher mode

Time Settings

Time range knob selects full scale time range. The t_{on} and t_{off} multiplier knobs provide fine adjustment of t_{on} and t_{off} time values within the full scale time range. Knob positions are latched upon startup to avoid accidental changes during operation. Therefore changing knob positions have no effect when the device is operational. The below example shows how to set particular t_{on} and t_{off} values

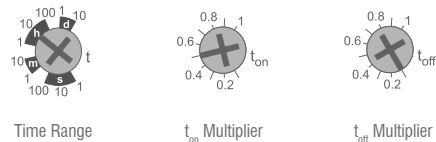

In the above figure: $t_{on} = 10h \times 0.5 = 5 \text{ hour}$ $t_{off} = 10h \times 0.1 = 1 \text{ hour}$

Note: All the pot values are digitalised. Cannot be set to mid values.

Connections

Power Input 24..300V AC/DC

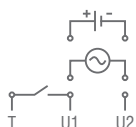

Relay

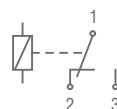

Dimensions (mm)

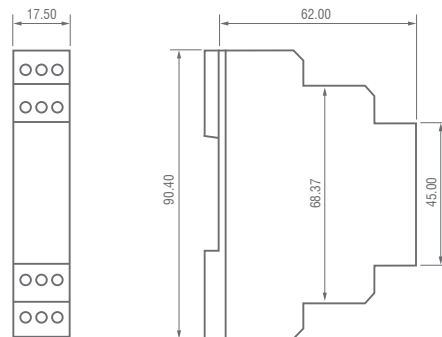

Mode Functions

ND - On Delay

The output relay is initially de-energised and energised after an adjustable time delay, t_{off} .

FD - Off Delay

The output relay is initially energised and de-energised after an adjustable time delay, t_{on} .

NFD - On-Off Delay

The output relay is initially de-energised and energised after an adjustable time delay, t_{off} and stays energised for an adjustable period, t_{on} , and then de-energised.

Fon - On Flasher

The output relay is initially energised and de-energised after an adjustable time delay, t_{on} and stays de-energised for an adjustable period, t_{off} , and then energised. This loop is repeated until the device is powered off.

Foff - Off Flasher

The output relay is initially de-energised and energised after an adjustable time delay, t_{off} and stays energised for an adjustable period, t_{on} , and then de-energised. This loop is repeated until the device is powered off.

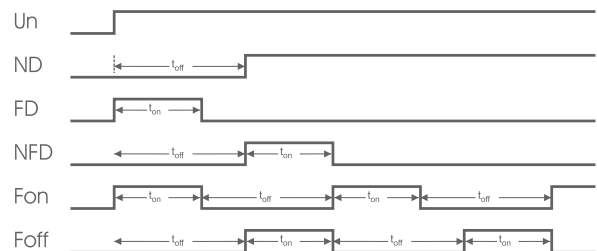

DIN Timers TDSD1



Key Features

- Star Delta DIN Timer
- Multi time range
- Compact design
- Single module size



Mode Functions

TDS1 star-delta starter is used for take-off starting method used in electrical motors. When energy applied from U1 and U2 terminals, star contacts will be energised until the end of the adjustable t_{λ} time. Later, at the end of the adjusted wait time $t_{\lambda-\Delta}$, delta contacts will be energised until the device powered off.

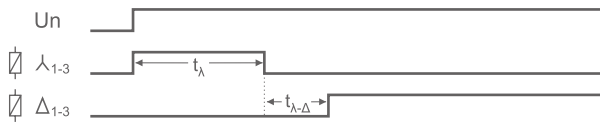

Dimensions (mm)

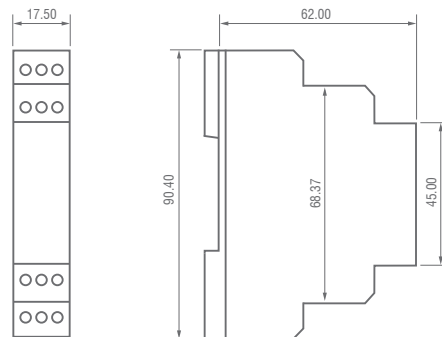

Connections

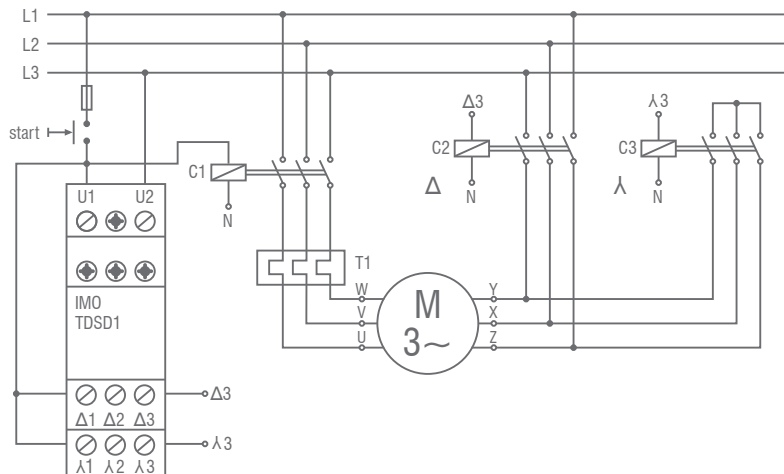

Power Input 150-500V AC



λ Relay

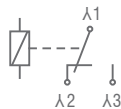

Δ Relay

