

AC Variable Speed Drives

0.40-710kW (0.55-950HP)



A solution for every **application**

IMO Jaguar AC Variable Speed Drives

The drive for perfection

We put more in, so you get more out...

- Better diagnostics - easy to programme in many languages
- Quicker response to dynamic load changes
- Connection to the latest industrial fieldbus systems
- A solution for every application



1984
VL series: First miniature 3Ø analogue drive



1986
CUB VC150: First low cost analogue 1Ø drive



1987
VL 11-22



1988
CD Mk1: First digital 3Ø inverter with RS485 comms



2013
VXH & VXA



2010
VXG



2007
VXR



2004
CUB:
1Ø and 3Ø series

Innovation

The product of thirty years continuous innovation, today's comprehensive range of IMO Jaguar variable speed drives remain at the very forefront of inverter technology.

In adopting a no compromise design philosophy the Jaguar range of drives are able to deliver long and trouble free service lives in a wide variety of environments. Worldwide the Jaguar drive is being used 24 hours a day, 7 days a week, 365 days a year, in applications ranging from fans and pumps through to the most demanding and complex machines.

Energy Saving

In today's energy conscious environment inverter technology is a key component in the fight to reduce global energy usage. IMO have long been a driving force behind the use of inverter drives in energy reduction programmes and our engineers have gained a vast wealth of knowledge and application experience in helping customers achieve their reduction targets. Visit www.jaguar-acdrives.com and use IMO's Energy Saving Calculator to work out the potential energy savings you could be making by fitting one of our Jaguar Variable Speed Drives to your pump or fan application.

www.jaguar-acdrives.com

Support

Boasting the largest stock of AC drives in the country, backed as always by our unique five year warranty, IMO is the only manufacturer in the world to underwrite your energy saving. Please visit www.imopc.com for ordering, stock availability, technical data, product approvals and software downloads.



www.imopc.com

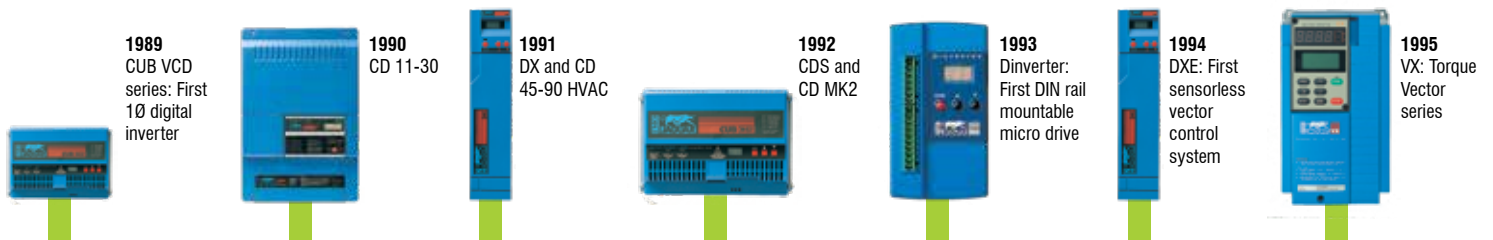

1989
CUB VCD series: First 1Ø digital inverter

1990
CD 11-30

1991
DX and CD 45-90 HVAC

1992
CDS and CD MK2

1993
Dinverter: First DIN rail mountable micro drive

1994
DXE: First sensorless vector control system

1995
VX: Torque Vector series

The only inverter in the world to underwrite your **Energy Saving for 5 years**



2003
TE: IP54 and LE: Lift/hoist specific

5m

2002
Over 5 million inverters installed worldwide

2001
VXSM

2000
VXM and CUB CM: First closed loop Dynamic Torque Vector Jaguar

1998
Common fieldbus options

1997
CUB C

1996
VXS: Compact low cost Torque Vector series

Which is the right Jaguar Drive for you?



General Purpose

FUNCTIONALITY



0.4 - 4.0kW

CUB



0.4 - 15kW

VXR



0.37 - 710kW

VXG

POWER

Industry Specific

FUNCTIONALITY



0.75 - 710kW

VXH



0.75 - 710kW

VXA



5.5 - 22kW

LFT

POWER

From our market leading CUB, VXR and VXG range of drives to the industry specific LFT, VXH and VXA drives, IMO has the ideal frequency inverter to meet the needs of your application, whatever it might be. From a simple conveyor to a major infrastructure project, you can be sure that IMO has the drive and knowledge to meet your application needs.

IMO Jaguar CUB

A compact body, simple operation, wide model variation and global compatibility; behind that is a drive with a dynamic performance that is head and shoulders above other products in this class. Application for the CUB include conveyors, fans, pumps, centrifugal separators and food processing machines.

IMO Jaguar VXR

With an extended range of functions and Dynamic Torque Vector Control the VXR sets new standards for vector controlled drives, yet still remains compact and cost effective. The VXR is frequently used on pumps, fans, conveyors, materials handling equipment, packaging, specialised process machinery and textile machines.

IMO Jaguar VXG

The flagship super high performance VXG multi-function inverter boasts state-of-the-art technology and a control performance that has evolved to a new dimension. Control methods now include: PG vector control, sensorless vector control, dynamic torque vector control and V/F control. With its extensive feature set and connectivity options the VXG meets the needs of the most demanding applications such as hoisting, materials handling, wood, textile, chemicals and other process machinery.

IMO Jaguar VXH (HVAC)

An energy saving drive designed to meet the exact demands of the building services industry. The VXH is equally at home as part of a structured BMS system or as a stand alone solution with its own built-in PLC, real time clock and four PID controllers. Available in IP21 or IP55 to reduce installation costs and with a wide range of bus standards, the VXH is the logical choice for air handling units, cooling fans and circulating pumps.

IMO Jaguar VXA (AQUA)

Sharing the same hardware configuration as the VXH drive, the VXA (Aqua) has features and functions tailored to satisfy the process and energy conservation requirements of the water industry. This includes linearization (which reduces terminal pressures during periods of low demand, thus reducing water wasted through leakage and seepage) and cascading pump control. Pump downtime can also be reduced by using the anti-ragging feature to reduce pump clogging. With a wide power range the VXA drive is the first choice for applications ranging from hot and cold water supply pumps up to large scale water infrastructure projects.

IMO Jaguar LFT

With its very high overload capability and industry specific feature set the LFT has become the benchmark for passenger lift drives. Able to operate open or closed loop, a fast internal processing speed virtually eliminates roll-back and the ability to operate from a battery supply ensures that passengers can be rescued in the event of a power failure. With a host of other features specifically for passenger lift applications, the IMO Jaguar LFT is the logical choice.

IMO Jaguar CUB

Micro-inverters

1Ø : 0.40-2.2kW (0.55-3HP)

3Ø : 0.40-4.0kW (0.55-5HP)



Key Features

- IP20 side-by-side mounting
- Optional integrated EMI filtered models
- RoHS, CE marked, UL / cUL approved
- Revolutionary diagnostics
- DC injection braking for fast stopping
- Input and output phase-loss protection
- High performance STV control
- PID control mode as standard
- Impact load stall prevention
- 7 user-configurable preset speeds
- 3 user-defined skip frequencies
- Sink / source logic
- Optional copy unit / remote operator
- Timer / one-shot operating mode
- Loss-of-load output signal
- Inputs configurable for ON / NOT-ON operation
- Life time / service due alarm output
- Internal brake chopper
- RS485 / Modbus RTU communication options
- Jaguar Loader diagnostic software



Ideal for OEM and end users alike, this powerful little inverter uses our latest Simplified Torque Vector open loop control architecture to give optimum torque output from a standard AC motor.

The Jaguar CUB drives deliver a higher motor starting torque using STV technology, a simplified version of IMO Jaguar's renowned torque-vector control system for consistently powerful operation. Running at 5Hz and employing both advanced magnetic flux estimator and motor slip compensation with auto-boost, starting torque can be as much as 150% or more.

The drive is available in ratings from 0.4kW through to 2.2kW in single phase / 230V, and 0.4kW to 4kW in 3 phase / 400V. CUBs rated 1.5kW and above can be specified with an integral braking resistor, while smaller models can be easily connected to an external bolt-on braking resistor option, making it ideal for applications such as stopping higher inertia loads that call for large reserves of regenerative braking power.

Thanks to its unique technology the Jaguar CUB improves voltage control performance and reduces motor instability at low speed delivering best in class performance at 1Hz or less. Even when the motor load fluctuates, the slip compensation function ensures smooth operation.

With its impressively high specification and feature set, the built-in benefits of the CUB make it the perfect choice for small applications such as fans, conveyors, chemical dosing pumps, chairlifts, lab mixers and food processing equipment.

Options & Ordering



Range		1 Phase				3 Phase			
Output Frequency	0.5 - 400Hz								
Overload Capacity	150% for 60 secs - 200% for 0.5 secs								
Power Supply Voltage	1 Phase, 200-240V, -15% / +10%				3 Phase, 380-480V, -15% / +10%				
Starting Torque	200% at 5Hz								
PWM Switching Frequency	0.75kHz - 14kHz								
Enclosure	IP20								
Communications	RS485 / Modbus RTU								
Dynamic Braking	Built-in								
EMC	Class A	External Option	Integrated		External Option	Integrated		External Option	Integrated
	Class B	External Option	Dim	External Option	Dim	External Option	Dim	External Option	Dim
Motor Power (kW/HP)	0.40/0.55	CUB3A-1	1A	CUB3A-1E	1B	CUB1A5-4	2B	CUB1A5-4E	2F
	0.75/1	CUB5A-1	1D	CUB5A-1E	2C	CUB2A5-4	2C	CUB2A5-4E	2G
	1.5/2	CUB8A-1	2E	CUB8A-1E	3G	CUB3A7-4	2C	CUB3A7-4E	2G
	2.2/3	CUB11A-1	3C	CUB11A-1E	3G	CUB5A5-4	2C	CUB5A5-4E	3G
	4/5.5	-	-	-	-	CUB9A-4	3C	CUB9A-4E	3G

Power & Control Connections

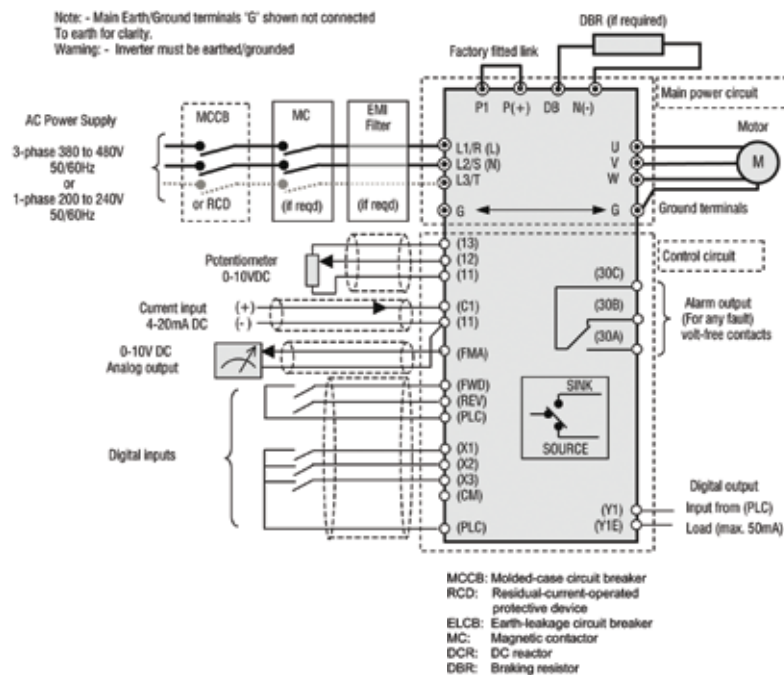

Dimensions (mm)

H	W	D	A	B	C	D	E	F	G
120	80	1	95	115		140			
130	110	2		115	139		149	158	
180	140	3			139				182

Accessories

Turn to accessories page for the complete range



Additional CUB Keypad



Comms Lead



Brake Resistor

IMO Jaguar VXR

The Mechanical Handling Solution



1Ø 230V : 0.40-2.2kW (0.55-3HP)
3Ø 400V : 0.40-15kW (0.55-20HP)

Key Features

- IP20 side-by-side mounting
- Optional integrated EMI filtered models
- Fast response to dynamic load changes - 64MHz CPU
- RoHS, CE, UL/cUL compliant
- V/F or Dynamic Torque Vector control
- 300% starting torque between 1-3Hz
- Improved open-loop low-speed stability
- Hit-and-Stop control with holding torque
- PID with dancer control
- PTC thermistor input
- Input and Output phase-loss protection
- Loss-of-command signal detection
- Life time / service due alarm output
- Internal brake chopper
- Mechanical brake control output - torque generated
- Thermostatically operated long-life cooling fans (designed to operate for 10 years at 40°C)
- RS485 (RJ-45 IN/OUT / Profibus / DeviceNet option cards)
- Optional multi-function back-lit keypad with parameter COPY mode
- Encoder feedback (closed-loop) and shaft-synchronizing options
- Synchronous (Permanent Magnet) motor options



The Jaguar VXR's wide range from 0.40kW to 15kW ratings come in 5 frame sizes in 200V series single and three-phase input, also 380-480V series three-phase input units, all with integrated braking.

With its class leading CPU Processing power, the VXR provides superior speed and positioning accuracy, allowing better control even with rapidly changing loads.

Every Jaguar VXR is supplied with a removable keypad as standard. The addition of a standard LAN cable offers a remote display which can be programmed to display up to 19 different readouts. An optional dual display backlit LCD keypad is available offering larger LED display for the selected readout as well as plain text programming and diagnostics. This display features a fully customisable menu so you can create the most operator-friendly parameter list for your own use, choosing as many or as few parameters as you like.

Equally at home on demanding lift or hoisting applications as on fans or pumps, VXR has a series of application groups enabling easy setup for the relevant control, such as brake control for lifting / indexing; multi-setpoint PID with sleep function; 2 stage PID on winding applications using dancer input. These are just a few of the many diverse tasks VXR can tackle.

Options & Ordering



Range		1 Phase				3 Phase			
Output Frequency		0.5 - 400Hz							
Overload Capacity		150% for 60 secs - 200% for 0.5 secs							
Power Supply Voltage		1 Phase, 200-240V, -15% / +10%				3 Phase, 380-480V, -15% / +10%			
Starting Torque		300% between 1-3Hz							
PWM Switching Frequency		0.75kHz - 15kHz							
Enclosure		IP20							
Communications		RS485 / Modbus RTU (Standard), Profibus, DeviceNet (Option Cards)							
Dynamic Braking		Built-in							
EMC	Class A	External Option		Integrated		External Option		Integrated	
	Class B	External Option		Dim	External Option	Dim	External Option		Dim
Motor Power (kW/HP)	0.40/0.55	VXR3A-1	1A	VXR3A-1E	1B	VXR1A5-4	2B	VXR1A5-4E	2E
	0.75/1	VXR5A-1	1C	VXR5A-1E	2C	VXR2A5-4	2C	VXR2A5-4E	2F
	1.5/2	VXR8A-1	2D	VXR8A-1E	3F	VXR3A7-4	2C	VXR3A7-4E	3F
	2.2/3	VXR11A-1	3C	VXR11A-1E	3F	VXR5A5-4	2C	VXR5A5-4E	3F
	4/5.5	-	-	-	-	VXR9A-4	3C	VXR9A-4E	3F
	5.5/7.5	-	-	-	-	VXR13A-4	4D	-	-
	7.5/10	-	-	-	-	VXR18A-4	4D	-	-
	11/15	-	-	-	-	VXR24A-4	5F	-	-
15/20	-	-	-	-	VXR30A-4	5F	-	-	

Power & Control Connections

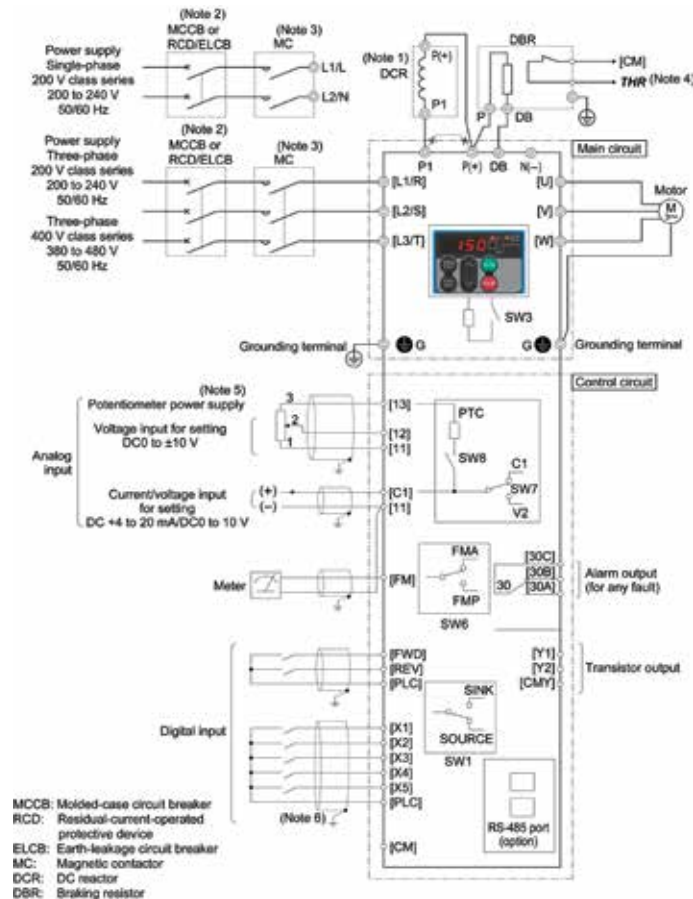

Dimensions (mm)

H	W	D	A	B	C	D	E	F
120	80	1	107	127	152			
130	110	2		127	152	160	169	
180	140	3			152			195
220	180	4				160		
260	220	5						195

Accessories

Turn to accessories page for the complete range



Optional Multi-Function Keypad



Comms Lead



Comms Module

IMO Jaguar VXG

High Performance Drives



3Ø : 0.40-710kW (0.55-950HP)

Key Features

- User configurable 'quick-start' menu
- IP20 side-by-side mounting (IP40 option kit)
- Integrated EMC filter (EN61800-3 2004 Cat. C3)
- PLC logic type function
- RoHS, CE, UL/cUL compliant
- V/F, Torque Vector and closed loop control
- Loss-of-command signal detection
- 200% starting torque between 0.3-5Hz
- Improved open-loop low-speed stability
- Safety input: digital input to enable / disable the IGBT devices of the inverter output stage
- Mechanical brake control output - torque generated
- PID thermistor input
- Input and Output phase-loss protection
- Life time / service due alarm output
- Thermostatically operated long-life cooling fans (designed to operate for 10 years at 40°C)
- Optional Keypad with mini USB port
- Standard multi-function back-lit keypad with parameter copy mode
- Encoder feedback (closed-loop) and shaft-synchronizing options
- Synchronous (Permanent Magnet) motor options
- Internal brake chopper up to 22kW (30-110kW upon request)



The Jaguar VXG is the next generation of inverter technology, taking over from the market leading VXM. It has been designed specifically to be a high performance, multifunctional inverter, that can answer the needs of today's most demanding applications.

The VXG represents a sensorless vector controlled drive and includes true closed-loop vector control when used with encoder feedback. With ratings ranging from 0.4kW to 710kW, this makes the VXG a high performance AC Drive boasting advanced EMC friendly technology suitable for the most demanding applications.

These applications range from presses, hoists, mixers and crushers to fans and pumps. Unlike other inverters currently on the market, the Jaguar series generates low electro-magnetic noise, which is associated with interference of other sensitive equipment. It has been carefully designed using soft switching techniques for both the power devices and the switch mode power supply devices, resulting in potentially troublesome emissions being greatly reduced.

The VXG features improved performance by providing a selection of control methods including: PG vector control, sensorless vector control, dynamic torque vector control and V/F control as well as improved performance of current response and speed response (vector control).

Options & Ordering

Range		3 Phase						
Output Frequency	0.5 - 500Hz							
Overload Capacity	150% for 60 secs - 200% for 3 secs							
Power Supply Voltage	3 Phase, 380-480V, -15% / +10%							
Starting Torque	200% / 0.3Hz							
PWM Switching Frequency	0.75kHz - 16kHz							
Enclosure	IP20							
Communications	RS485 / Modbus RTU (Standard), Profibus, DeviceNet, CC-Link, CANopen (Option Cards)							
Dynamic Braking	Built-in up to 22kW							
EMC	Cat. C3	Integrated						
Motor Power (kW/HP)	C.T Rating	V.T Rating	Dim	C.T Rating	V.T Rating	Dim		
0.4/0.55			VXG1A5-4E	1A	55/75	75/100	VXG150AL-4E	7E
0.75/1			VXG2A5-4E	1B	75/100	90/125	VXG176AL-4E	8E
1.5/2.2			VXG4A-4E	2B	90/125	110/150	VXG210AL-4E	9F
2.2/3			VXG5.5A-4E	2B	110/150	132/200	VXG253AL-4E	9F
4/5.5			VXG9A-4E	2B	132/200	160/250	VXG304AL-4E	10G
5.5/7.5	7.5/10		VXG16A5L-4E	3C	160/250	200/300	VXG377AL-4E	10G
7.5/10	11/15		VXG23AL-4E	3C	200/300	220/350	VXG415AL-4E	11G
11/15	15/20		VXG30A5L-4E	3C	220/350	280/450	VXG520AL-4E	11G
15/20	18.5/25		VXG37AL-4E	4C	280/450	315/500	VXG650AL-4E	12H
18.5/25	22/30		VXG45AL-4E	4C	315/500	355/470	VXG740AL-4E	12H
22/30	30/40		VXG60AL-4E	4C	355/470	400/600	VXG840AL-4E	13H
30/40	37/50		VXG75AL-4E	5D	400/600	500/700	VXG960AL-4E	13H
37/50	45/60		VXG91AL-4E	5D	500/700	630/900	VXG1170AL-4E	14I
45/60	55/75		VXG112AL-4E	6E	630/900	710/950	VXG1370AL-4E	14I

Power & Control Connections

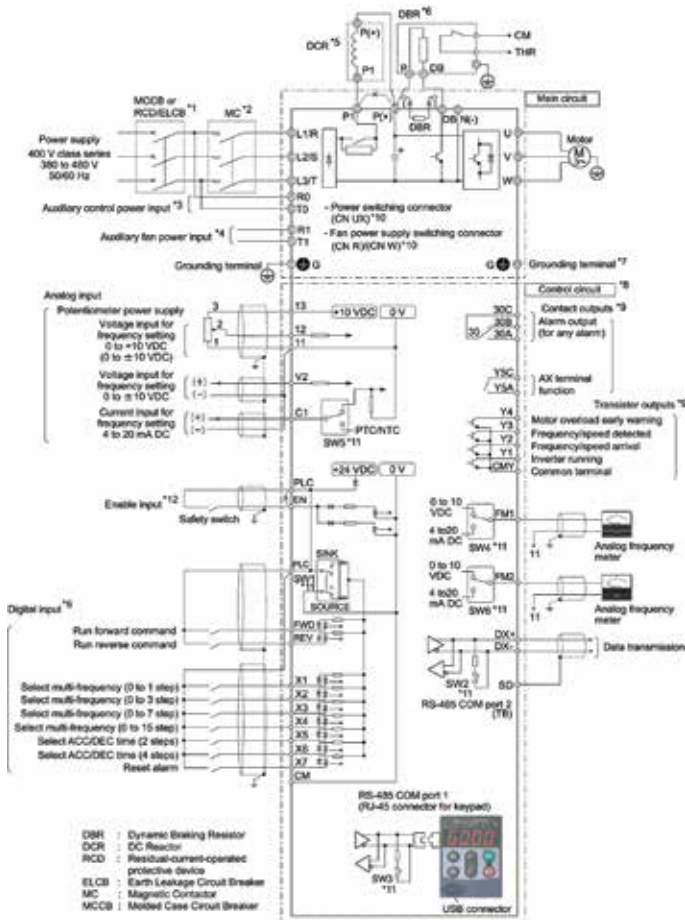

Dimensions (mm)

H	W	D	A	B	C	D	E	F	G	H	I
260	110	1	132	145							
260	150	2		145							
260	220	3			195						
400	250	4			195						
550	326	5				225					
615	361	6					270				
675	361	7					270				
740	361	8					270				
740	536	9						315			
1000	536	10							360		
1000	680	11								360	
1400	680	12									440
1400	880	13									440
1550	1000	14									500

Accessories

Turn to accessories page for the complete range



Additional Multi-Function Keypad

IMO Jaguar VXH

The HVAC Solution



3Ø : 0.75-710kW (1-950HP)

Key Features

- Torque vector control
- User friendly, informative keypad
- Automatic energy-saving operation
- IP21 & IP55 up to 90kW
- DC Reactor and built-in up 90kW
- EMC Filter standard in all units
- Built-in PLC
- 4 built in PID controllers
- Real time clock / Timer functions
- Regenerative avoidance control
- Wet-bulb temperature estimation control
- Linearization function
- Fire mode (forced operation)
- Pick-up rotating motor function
- Filter clogging prevention function
- Password function
- Broken belt detection
- Cumulative kWh data logger
- Standard comms: BACnet MS/TP, Modbus RTU & Metasys N2
- Optional comms: LonWorks, DeviceNet, Ethernet, CANopen, Profibus, CC-Link



The IMO Jaguar VXH range can make a significant reduction in global energy usage

Up to 50% of energy consumption in schools, hospitals, shopping centres, hotels and office buildings is related to air conditioning. The IMO Jaguar VXH series is a dedicated inverter for HVAC applications that offers functions and features designed to create the optimal environment for the people using the building, whilst keeping the energy consumption in AHUs, water pumps, compressors, condensers, and others to a minimum.

Equally at home as part of a BMS system or as a stand alone solution the IMO Jaguar VXH range has been designed specifically for energy saving and can significantly help to reduce our Global Carbon Footprint.

Wide range from 0.75kW to 710kW

All drives have built-in EMC filter as standard. Additionally drives up to 90kW have DC reactor built-in as standard and are available as IP21 or IP55, thus offering a wide range of installation options.

IMO Jaguar VXA

The Water Industry Drive

3Ø : 0.75-710kW (1-950HP)

Key Features

- Torque vector control
- User friendly, informative keypad
- Automatic energy-saving operation
- IP21 & IP55 up to 90kW
- DC Reactor built-in up 90kW
- EMC Filter standard in all units
- Built-in PLC
- 4 built in PID controllers
- Real time clock / Timer functions
- Cascading pump control
- Anti Ragging / Anti Jamming
- Max starts per hour control
- Dry pump detection
- Check valve protection
- End of curve detection
- Linearization function
- Fire mode (forced operation)
- Password function
- Cumulative kWh data logger
- Wet-bulb temperature estimation control
- Standard comms: BACnet MS/TP, Modbus RTU & Metasys N2
- Optional comms: LonWorks, DeviceNet, Ethernet, CANopen, Profibus, CC-Link



The IMO Jaguar VXA range has been designed to satisfy the requirements of the water industry

From a single pump irrigation system to a multi-pump infrastructure project the IMO Jaguar VXA (Aqua) is the obvious choice. With a parameter set boasting every function you are ever likely to require in a pumping application this is a single drive fits all solutions.

Energy conservation is of paramount importance within the water industry and in addition to the obvious energy reduction gained through controlling the speed the VXA (AQUA) offers many other benefits to further boost its green credentials, such as linearization which reduces terminal pressures during periods of low demand, thus reducing water wasted through leakage and seepage. Pump downtime can also be reduced by using the anti-ragging feature to reduce pump clogging.

Wide range from 0.75kW to 710kW

All drives have built-in EMC filter as standard. Additionally drives up to 90kW have DC reactor built-in as standard and are available as IP21 or IP55, thus offering a wide range of installation options.



Options & Ordering

Range		3 Phase				
Output Frequency		0 - 120Hz				
Overload Capacity		110% for 60 secs				
Power Supply Voltage		3 Phase, 380-480V, -15% / +10%				
Starting Torque		up to 200% / 0.3Hz				
PWM Switching Frequency		0.75kHz - 16kHz				
Enclosure		IP00/21/55				
Communications		BACnet MS/TP, Modbus RTU and Metasys N2 (included)				
Dynamic Braking		Option				
EMC	Cat C2/C3	Integrated				
DCR		Built-in		Option		
Enclosure		IP21 / IP55	Dim	IP00	Dim	
(kW/HP)	0.75/1	VXH2A5 / VXA2A5	A	75/100	VXH150 / VXA150	E
	1.5/2	VXH4A1 / VXA4A1	A	90/125	VXH176 / VXA176	E
	2.2/3	VXH5A5 / VXA5A5	A	110/150	VXH210 / VXA210	F
	4/5.5	VXH9 / VXA9	A	132/200	VXH253 / VXA253	F
	5.5/7.5	VXH13A5 / VXA13A5	A	160/250	VXH304 / VXA304	G
	7.5/10	VXH18A5 / VXA18A5	A	200/300	VXH377 / VXA377	G
	11/15	VXH24A5 / VXA24A5	B	220/350	VXH415 / VXA415	H
	15/20	VXH32 / VXA32	B	280/450	VXH520 / VXA520	H
	18.5/25	VXH39 / VXA39	B	315/500	VXH585 / VXA585	I
	22/30	VXH45 / VXA45	B	355/470	VXH650 / VXA650	I
	30/40	VXH60 / VXA60	C	400/600	VXH740 / VXA740	I
	37/50	VXH75 / VXA75	C	500/700	VXH960 / VXA960	J
	45/60	VXH91 / VXA91	D	630/900	VXH1170 / VXA1170	K
	55/75	VXH112 / VXA112	D	710/950	VXH1370 / VXA1370	K

Power & Control Connections

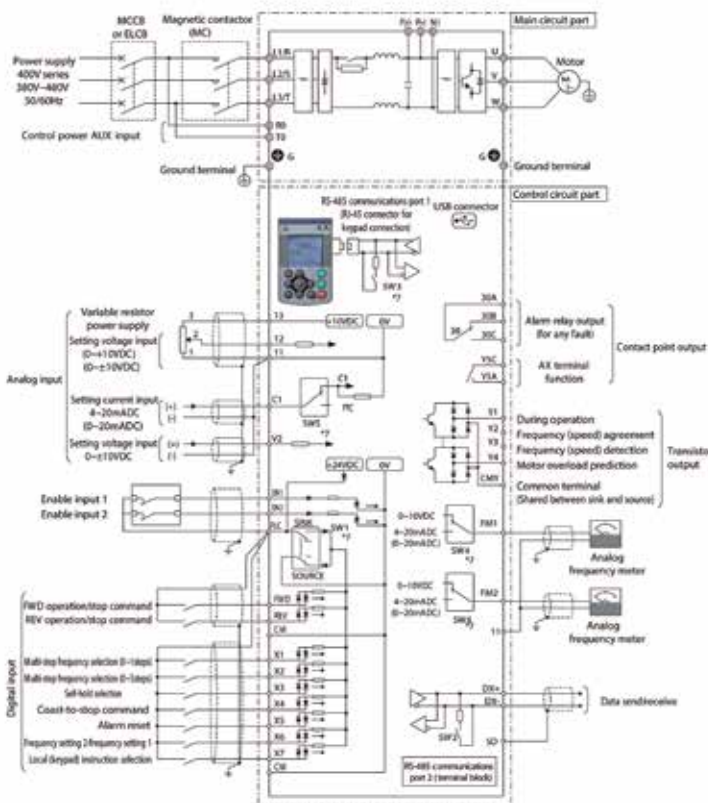

Dimensions (mm)

H	W	D	FRAME	MOTOR POWER (kW)
465	150		A	0.75 - 7.5
585	203	262	B	11 - 22
645			C	30 - 37
736	265	284	D	45 - 55
885	300	367.9	E	75 - 90
740		315	F	110 - 132
1000	530		G	160 - 200
	680	360	H	220 - 280
1400		440	I	315 - 400
	880		J	500
1550	1000	500	K	630 - 710

Accessories

Turn to accessories page for the complete range



Additional Keypad

IMO Jaguar LFT

The Benchmark For Lifts

3Ø : 4-45kW (5.5-60HP)



Key Features

- Very high overload capability: 200% of rated current for 10 seconds
- Rated for a very heavy duty: 80% ED at 45°C ambient temperature
- Fast current response, obtaining a low torque ripple and very good rollback correction without using load cell
- Speed accuracy of $\pm 0.01\%$
- Safety input: digital input to enable / disable the IGBT devices of the inverter output stage
- Remote/Local operation can be easily switched by pressing one key
- Allows saving of complete parameter sets of three inverters
- Pole-tuning of permanent magnet synchronous motor can be performed without motor rotation
- 1 RS485 port as standard, with ModBus RTU and DCP 3 protocols
- CAN hardware is integrated which allows CAN Open communication
- Brake control function
- 16 kHz switching frequency (non audible motor noise)
- Allows the definition of the Quick Access Menu (menu 0)
- Can be connected remotely using standard LAN cable
- Short floor operation
- 3 speed loop PI gains sets: one for zero speed, one for low speed and one for high speed
- Very simple rescue operation (using battery / UPS)
- Main contactors control function
- Powerful ramp generator (10 different linear ramps and 10 different S curves)
- Direct-to-floor operation (operation without creep speed)
- Anticipated door opening, Speed error detection, Auto-reset function
- The cooling fan can be automatically disconnected when the inverter is cold, increasing the life of the fan and avoiding excessive acoustic noise when the inverter is not operating



The Jaguar range of LFT is aimed at giving lift applications a significant performance boost. Of particular note is the LFT's ability to be driven by battery power, thus allowing otherwise trapped lift passengers to be rescued quickly and easily in the event of mains power failure.

The LFT has a unique input function that uses timers to filter any difference between BRKS and BRKE signals to check that the lift brake has actually operated. A dedicated brake control signal (BRKS) means that the LFT directly controls the opening and closing of the mechanical brake without assistance from the main lift controller. The LFT also contains built-in adjustable timers to delay the BRKS signal in order to match the mechanical brakes' actual opening and closing time.

Other features include a restart time function, which avoids damage from contactor racing causing harmful regenerative currents emanating from the motor, and a contactor controller which times the opening and closing of the magnetic contactor in sequence with the inverter and motor operation. Thus, start and end delay times allow contactor operation without making or breaking motor current.

In closed loop applications the LFT does not need an external signal for zero speed command. This helps to avoid shock at starting and stopping due to car roll-back. In open loop applications to avoid possible "jolts" the user can choose between start using a pre-programmed starting frequency held for a period of time, or start by holding on DC braking for a short time.

The LFT includes a match timer to validate speed change commands. This function is useful for lift controllers using relays for output switching that could bounce and give false signals to the inverter drive.

IMO Jaguar Accessories

Available off the shelf, IMO has all the add-ons you need to integrate Jaguar drives into complete system solutions.

EMC Filters

High frequency conducted emissions can disturb other sensitive equipment connected to a shared power supply. Fitting the correct filter to your drive will reduce radio frequency interference (RFI) and minimise the risk of problems.

All Jaguar drives and filters are CE marked and comply with relevant European standards when installed in accordance with instruction manuals and EC Declarations of Conformity.

Filter Part No.	Filter Type	Related Jaguar Inverter
RF175-M	Free standing, Cat C3	All 1 PH up to 0.75kW
RF150-MH	Free standing, Cat C3	All 1 PH up to 1.5kW
RF5A5-4B	Footprint, Cat C1	CUB1A5-4, CUB2A5-4, CUB3A7-4, CUB5A5-4, VXR1A5-4, VXR2A5-4, VXR3A7-4, VXR5A5-4
RF5A-1B	Footprint, Cat C1	CUB3A-1, CUB5A-1, VXR3A-1, VXR5A-1
RF9A-4B	Footprint, Cat C1	CUB9A-4, VXR9A-4
RF8A-1B	Footprint, Cat C1	CUB8A-1, VXR8A-1
RF11A-1B	Footprint, Cat C1	CUB11A-1, VXR11A-1
RF18A-4B	Footprint, Cat C1	VXR13A-4, VXR18A-4
RF30A-4B	Footprint, Cat C1	VXR24A-4, VXR30A-4
RF2A5-4B	Footprint, Cat C1	VXG1A5-4E, VXG2A5-4E
RF10A-4B	Footprint, Cat C1	VXG4A-4E, VXG5A5-4E, VXG9A-4E
RF23A-4B	Footprint, Cat C1	VXG16A5L-4E, VXG23AL-4E
RF30A5-4B	Footprint, Cat C1	VXG30A5L-4E
RF60A-4B	Footprint, Cat C1	VXG37AL-4E, VXG45AL-4E, VXG60AL-4E
RF75A-4B	Free standing, Cat C2	VXG75AL-4E
RF176A-4B	Free standing, Cat C2	VXG91AL-4E, VXG112AL-4E, VXG150AL-4E, VXG175AL-4E
RF304-4B	Free standing, Cat C3	VXG210AL-4E, VXG253AL-4E, VXG304AL-4E
RF520A-4B	Free standing, Cat C3	VXG377AL-4E, VXG415AL-4E, VXG520AL-4E
RF840A-4B	Free standing, Cat C3	VXG650AL-4E, VXG740AL-4E, VXG840AL-4E
RF960A-4B	Free standing, Cat C3	VXG960AL-4E
RF1370-4B	Free standing, Cat C3	VXG1370AL-4E



DC and AC Reactors

Essential in electronic drive installations, DC and AC reactors reduce low order harmonic distortion in the main power supply system, improve power factor and reduce damaging fault currents in the event of a short-circuit at a drive's input terminals. If a very long motor cable has to be used, an AC reactor on the output side of a drive can limit peak voltages that could damage the motor's insulation and prevent nuisance over-current alarms due to cable charge-up.

Part No.	Motor (kW)	Amps (A)	Impedance (mH)
VXLC0.4	0.4	1.5	50
VXLC0.75	0.75	2.5	30
VXLC1.5	1.5	4	16
VXLC2.2	2.2	5.5	12
VXLC4.0	4	9	7
VXLC5.5	5.5	13	4
VXLC7.5	7.5	18	3.5
VXLC11	11	22	2.5
VXLC15	15	34	1.8
VXLC18	18.5	41	1.4
VXLC22	22	49	1.3
VXLC30	30	80	0.86
VXLC37	37	100	0.7
VXLC45	45	120	0.58
VXLC55	55	146	0.47
VXLC75	75	200	0.35
VXLC90	90	238	0.29
VXLC110	110	291	0.24
VXLC132	132	326	0.215
VXLC160	160	395	0.177
VXLC200	200	494	0.142
VXLC220	220	557	0.126
VXLC280	280	700	0.1



AC reactors are also available.
Contact IMO for price and availability.

Keypad, Cables & Option Cards

A range of option cards are available for the following applications:

Synchronisation (SY)	Synchronises the speed of two identical geared motors in master/slave mode. VXR and VXG only.
Encoder feed back (EFC)	Maintains constant shaft speed of an induction motor via high accuracy speed control and fast response to step loading, and can also enable a motor to develop full torque at zero speed. VXR and VXG only.
Analog (AIO), Digital (DIO), Relay (RY)	Expand standard input and output functions etc, and convert transistor outputs to relay outputs
Remote operator panel / copy unit	For remote operation and display. CUB, VXR and VXG.
RS485	A miniature interface board for serial communications. CUB only.
Fieldbus	Plug-in Profibus DP and DeviceNet modules are amongst the many high-speed factory automation protocols available contact IMO for more details.

Part No.	CUB	VXR	VXG	VXH / VXA
RS485 / Modbus RTU	CUBRS485	Standard	Standard	-
Relay Output Card	-	-	OPC-G1-RY	OPC-G1-RY
Digital Output Card	-	-	OPC-G1-DO	-
Digital Input Card	-	-	OPC-G1-DI	-
Digital I/O Card	-	VXR-DIO	-	-
Analogue I/O Card	-	-	OPC-G1-AIO	OPC-G1-AIO
Analogue Current I/O Card	-	-	-	OPC-G1-AO
PG Card	-	VXR-EFC	OPC-G1-PG	-
Sync Card	-	VXR-SY	-	-
Device Net	-	VXR-DEV	OPC-G1-DEV	OPC-G1-DEV
Profibus DP	-	VXR-PROF	OPC-G1-PDP	OPC-G1-PDP
CANopen	-	-	OPC-G1-COP	OPC-G1-COP
LonWorks	-	-	-	OPC-G1-LNW
Ethernet	-	-	OPC-G1-ETH	OPC-G1-ETH
T-Link	-	-	OPC-G1-TL	-
CC-Link	-	-	OPC-G1-CCL	OPC-G1-CCL
SX-Bus Card	-	-	OPC-G1-SX	-
Multi Function Keypad	CUB-KEYPAD	OP-KP-LCD	OP-KP-LCD	-
USB Keypad	-	OP-KP-USB	OP-KP-USB	-
1m Connection Cable	JAGLEAD1M	JAGLEAD1M	JAGLEAD1M	JAGLEAD1M
2m Connection Cable	JAGLEAD2M	JAGLEAD2M	JAGLEAD2M	JAGLEAD2M
3m Connection Cable	JAGLEAD3M	JAGLEAD3M	JAGLEAD3M	JAGLEAD3M
Pt100 Temp. Sensor Input Card	-	-	-	OPC-G1-PT
Battery	-	-	-	OPK-BP

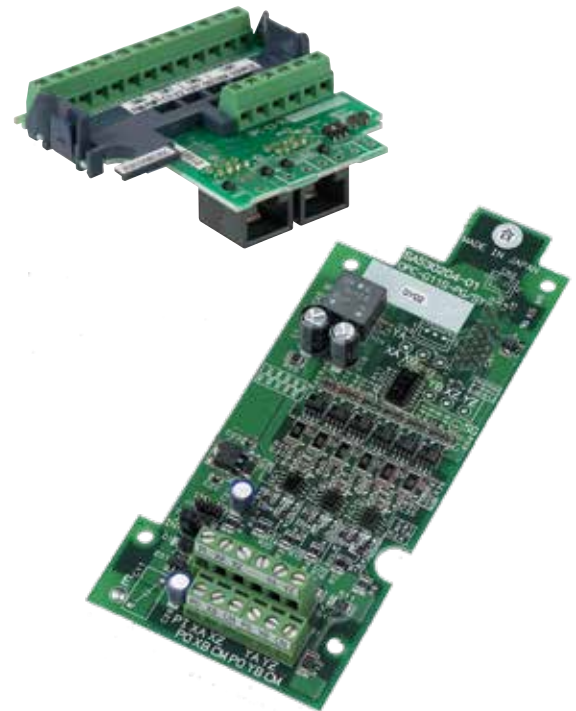

Dynamic Braking Resistors

High-speed, solid-state switches are used to aid the stopping or slowing of high inertia loads from high speed or to prevent a load overhauling a motor. Regenerated energy must be dissipated into a specified resistor(s) to prevent the drive tripping on over-voltage. For advice on the required braking resistors for your application please contact IMO.

Part No.	Type	Resistance (ohms)	Power (w)
DBR100R400W	Extruded/IP55	100	400
DBR110R500W	Extruded/IP55	110	500
DBR160R400W	Extruded/IP55	160	400



Ancillaries

The IMO Jaguar range also offers a wide selection of ancillaries that include keypad extension cables, potentiometers, relays, rpm readouts and many more. For full listing please contact IMO.



IMO Jaguar Loader

FREE Software

- Control test
- Monitor
- Print
- Trend
- Commission
- Fault-find
- Transfer
- Program
- Save

Free to download from our web site, Windows™- compatible (XP or later) Loader lets you upload, download, and verify data between inverters. The copy facility allows you to save data for multi-drive installations. You can also create real-time trend graphs of frequency, current, torque, voltage, etc. and control and monitor the alarm status of an operating motor.

RS232/485 converter (available from IMO) is needed to connect a PC to Jaguar VXG, VXR or CUB, VXH and VXA (with RS485 interface option).

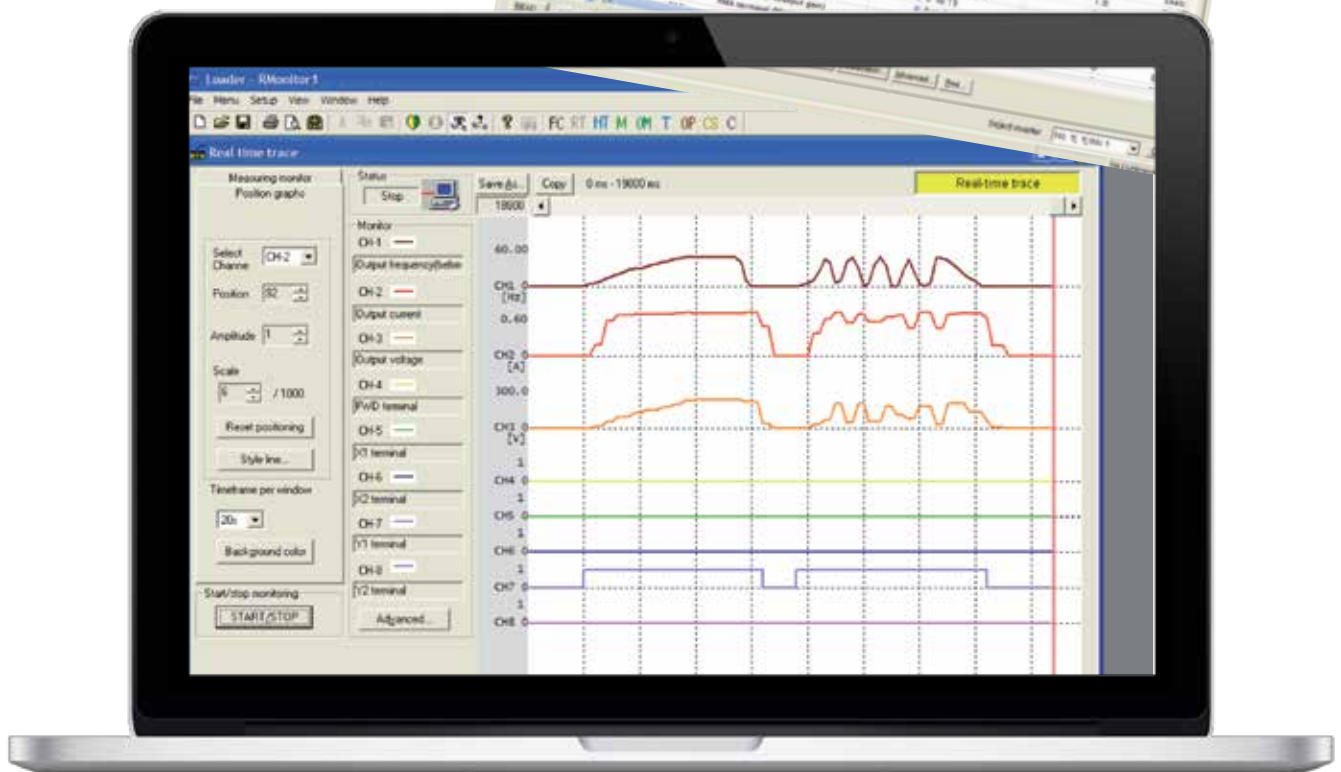
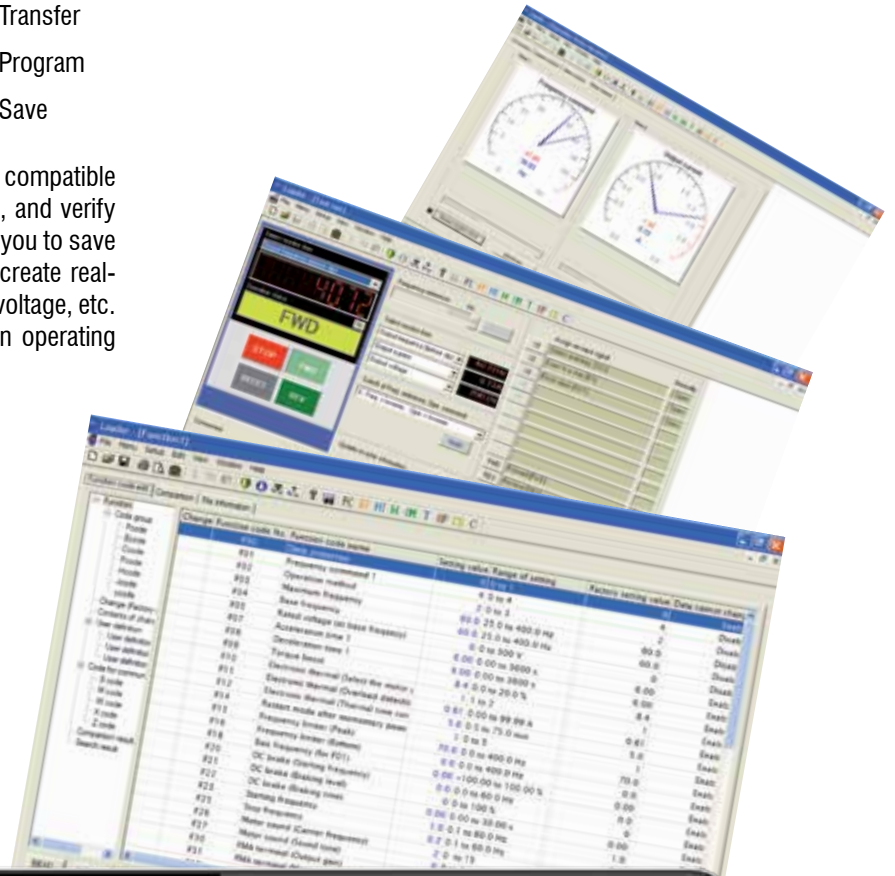

Also Available From IMO

From a single product to a complete application solution, IMO has the product range and knowledge to meet today's most demanding application requirements...

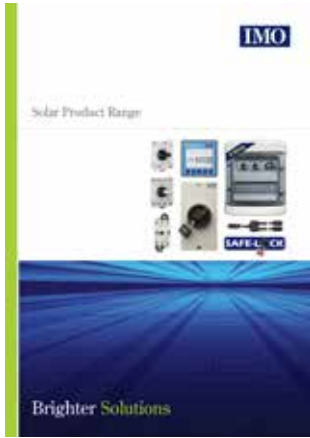

Solar Product Range

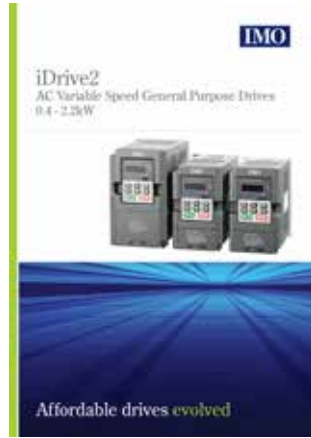

iDrive2 Low-Cost Drives



Miniature Circuit Breakers



Panel Product Range



Relays



PCB Terminal Blocks

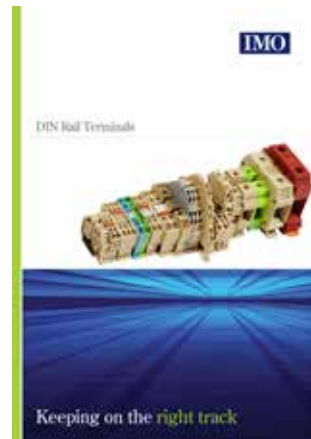

DIN Rail Terminals

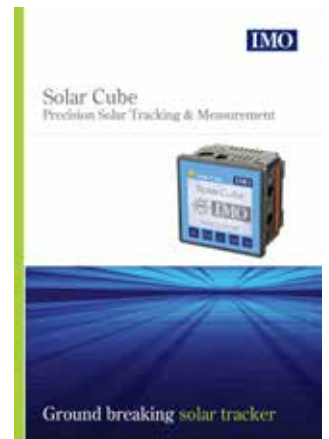

Solar Cube



iView Advanced HMI

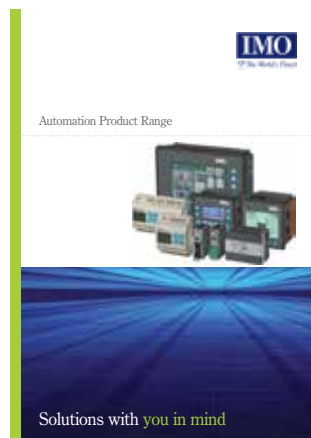

Automation Product Range



iConnect (Remote M2M)



Push Buttons (Online Only)

...visit www.imopc.com for a full range of products and downloadable brochures

IMO Worldwide Offices

IMO Precision Controls Limited

The Interchange
Frobisher Way
Hatfield, Herts AL10 9TG
United Kingdom

Tel: 01707 414 444
Fax: 01707 414 445
Email: imo@imopc.com
Web: www.imopc.com

IMO Jeambrun Automation SAS

5, Rue Alfred De Musset
94100
Saint-Maur-Des-Fosses
France

Tel: 0800 912 712 (n° gratuit)
Fax: 0145 134 737
Email: imo-fr@imopc.com
Web: www.imojeambrun.fr

IMO Automazione

Via Belfiore 10,
50144 Firenze (FI)
Italia

Tel: 800 930 872 (toll free)
Fax: 8000 452 6445
Email: imo-it@imopc.com
Web: www.imopc.it

IMO Canada

Unit 32 - B - North
18 Strathearn Avenue, Brampton
Ontario L6T 4Y2
Canada

Tel: 905 799 9237
Fax: 905 799 0450
Email: imo-ca@imopc.com
Web: www.imopc.com

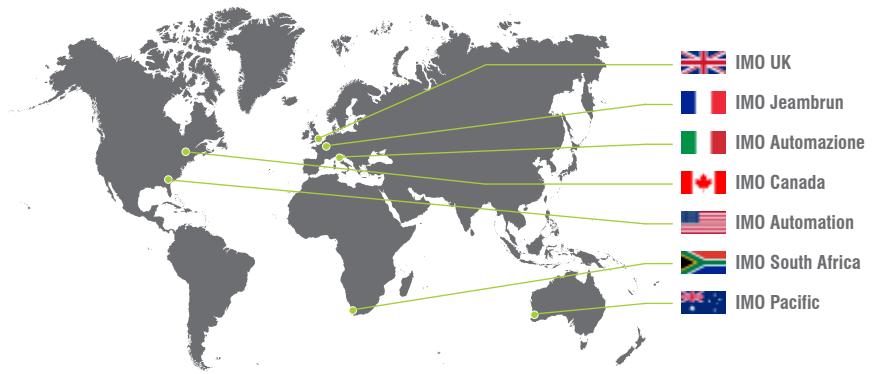

IMO Automation LLC

Steeplechase Industrial Park
Suite E, 5845 Steeplechase Blvd
Cumming, GA 30040
USA

Tel: 404 476 8810
Fax: 678 679 7112
Email: imo-usa@imopc.com
Web: www.imoautomation.com

IMO South Africa (Pty) Ltd

G16 Centurion Business Park
Montague Gardens
Cape Town 7441
South Africa

Tel: 021 551 1787
Fax: 021 555 0676
Email: info@imopc.co.za
Web: www.imopc.co.za

IMO Pacific Pty Ltd

Unit 9, Dillington Pass
Landsdale
Perth WA 6065
Australia

Tel: 1300 34 21 31
Fax: 08 9303 9908
Email: sales@imopacific.com.au
Web: www.imopacific.com.au