

DIN rails are standardized and certified according to EN 60715. Used to mount components and devices (terminal blocks, circuit breakers, contactors, pads etc.), and are available in different versions: in a depth of 7,5 mm or 15 mm, solid or perforated with holes of various diameters and lengths. Standardized delivered length is 2000 mm. Unified shorter lengths are available on request.

In addition to these lengths can be supplied rails in any length till 2000 mm and in minimum order quantity of 100 pieces. Besides the offered profiles, there are also specific profiles supplied. DIN rails are made of steel class. 11, surfaced in design Sendzimir according to EN 10346-2009-03. We can deliver also customized rails made of copper, aluminium or stainless steel.

## TS 35 x 7,5 solid

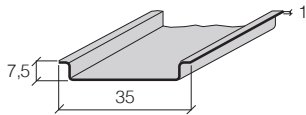

| Order code | Length (mm) | Weight (g) | Package (m) |
|------------|-------------|------------|-------------|
| MMD7520A29 | 2000        | 680        | 40          |
| MMD7510A29 | 1000        | 340        | 20          |

## TS 35 x 7,5 perforated (5,2 x 25 mm)

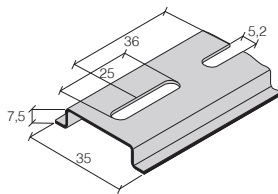

| Order code | Length (mm) | Weight (g) | Package (m) |
|------------|-------------|------------|-------------|
| MMD7520B29 | 2000        | 600        | 40          |
| MMD7510B29 | 1000        | 300        | 20          |

## TS 35 x 7,5 perforated (6,3 x 18 mm)

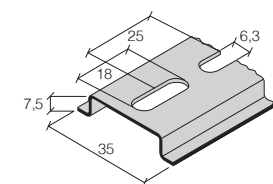

| Order code | Length (mm) | Weight (g) | Package (m) |
|------------|-------------|------------|-------------|
| MMD7520C29 | 2000        | 600        | 40          |
| MMD7510C29 | 1000        | 300        | 20          |

## TS 35 x 15 solid

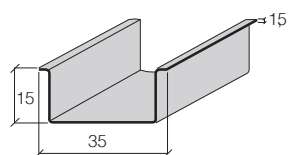

| Order code | Length (mm) | Weight (g) | Package (m) |
|------------|-------------|------------|-------------|
| MMD1520A29 | 2000        | 1320       | 20          |
| MMD1510A29 | 1000        | 660        | 10          |

## TS 35 x 15 perforated (5,2 x 25 mm)

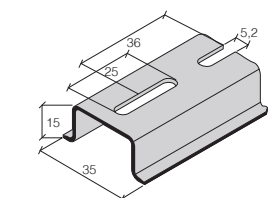

| Order code | Length (mm) | Weight (g) | Package (m) |
|------------|-------------|------------|-------------|
| MMD1520B29 | 2000        | 1200       | 20          |
| MMD1510B29 | 1000        | 600        | 10          |

## TS 35 x 15 perforated (6,3 x 18 mm)

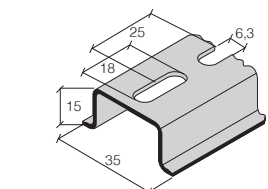

| Order code | Length (mm) | Weight (g) | Package (m) |
|------------|-------------|------------|-------------|
| MMD1520C29 | 2000        | 1200       | 20          |
| MMD1510C29 | 1000        | 600        | 10          |

DIN rails are standardized and certified according to EN 60715. Used to mount components and devices (terminal blocks, circuit breakers, contactors, pads etc.), and are available in different versions: in a depth of 7,5 mm or 15 mm, solid or perforated with holes of various diameters and lengths. Standardized delivered length is 2000 mm. Unified shorter lengths are available on

request. In addition to these lengths can be supplied rails in any length till 2000 mm and in minimum order quantity of 100 pieces. Besides the offered profiles, there are also specific profiles supplied. DIN rails are made of steel class 11, surfaced in design galvanic zinc plating and passivation. We can deliver also customized rails made of copper, aluminium or stainless steel.

**TS 35 x 7,5 Galvanic Zn solid**

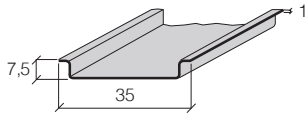

| Order code | Length (mm) | Weight (g) | Package (m) |
|------------|-------------|------------|-------------|
| MMD7520Z00 | 2000        | 680        | 40          |
| MMD7510Z00 | 1000        | 340        | 20          |

**TS 35 x 7,5 Galvanic Zn perforated (5,2 x 25 mm)**

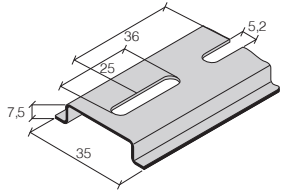

| Order code | Length (mm) | Weight (g) | Package (m) |
|------------|-------------|------------|-------------|
| MMD7520Z52 | 2000        | 600        | 40          |
| MMD7510Z52 | 1000        | 300        | 20          |

**TS 35 x 7,5 Galvanic Zn perforated (6,3 x 18 mm)**

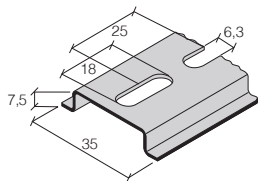

| Order code | Length (mm) | Weight (g) | Package (m) |
|------------|-------------|------------|-------------|
| MMD7520Z63 | 2000        | 600        | 40          |
| MMD7510Z63 | 1000        | 300        | 20          |

**TS 35 x 15 Galvanic Zn solid**

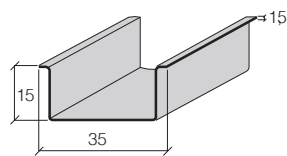

| Order code | Length (mm) | Weight (g) | Package (m) |
|------------|-------------|------------|-------------|
| MMD1520Z00 | 2000        | 1320       | 20          |
| MMD1510Z00 | 1000        | 660        | 10          |

**TS 35 x 15 Galvanic Zn perforated (5,2 x 25 mm)**

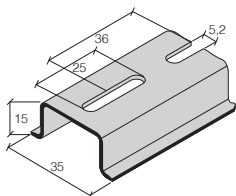

| Order code | Length (mm) | Weight (g) | Package (m) |
|------------|-------------|------------|-------------|
| MMD1520Z52 | 2000        | 1200       | 20          |
| MMD1510Z52 | 1000        | 600        | 10          |

**TS 35 x 15 Galvanic Zn perforated (6,3 x 18 mm)**

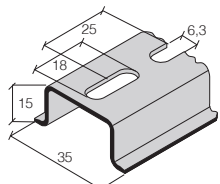

| Order code | Length (mm) | Weight (g) | Package (m) |
|------------|-------------|------------|-------------|
| MMD1520Z63 | 2000        | 1200       | 20          |
| MMD1510Z63 | 1000        | 600        | 10          |

DIN rail brackets are used for mounting of DIN rails and defining the distance between the device and the installation cabinet wall. Sloping DIN brackets are used to fix the mounting rail in an angle of 30°.

It is possible to place DIN rails on the flat brackets horizontally to the wall. All brackets have an opening with metric thread M6 piece for easy and convenient connection to the DIN rail. DIN rail brackets are made of steel surfaced by zinc.

## DIN rail bracket – flat



| Order code | Type                      | Thread | Package (pcs) |
|------------|---------------------------|--------|---------------|
| MMD6420A23 | DIN rail bracket flat H20 | M6     | 50            |
| MMD6425A23 | DIN rail bracket flat H25 | M6     | 50            |
| MMD6430A23 | DIN rail bracket flat H30 | M6     | 50            |
| MMD6440A23 | DIN rail bracket flat H40 | M6     | 50            |
| MMD6450A23 | DIN rail bracket flat H50 | M6     | 50            |
| MMD6470A23 | DIN rail bracket flat H70 | M6     | 50            |
| MMD6490A23 | DIN rail bracket flat H90 | M6     | 50            |

## DIN rail bracket – sloping - pitch of the mounting holes 60 mm



| Order code | Type                         | Thread | Package (pcs) |
|------------|------------------------------|--------|---------------|
| MMD6049B23 | DIN rail bracket sloping H49 | M6     | 50            |
| MMD6058B23 | DIN rail bracket sloping H58 | M6     | 50            |
| MMD6068B23 | DIN rail bracket sloping H68 | M6     | 50            |
| MMD6078B23 | DIN rail bracket sloping H78 | M6     | 50            |
| MMD6088B23 | DIN rail bracket sloping H88 | M6     | 50            |
| MMD6098B23 | DIN rail bracket sloping H98 | M6     | 50            |

## Dimensions

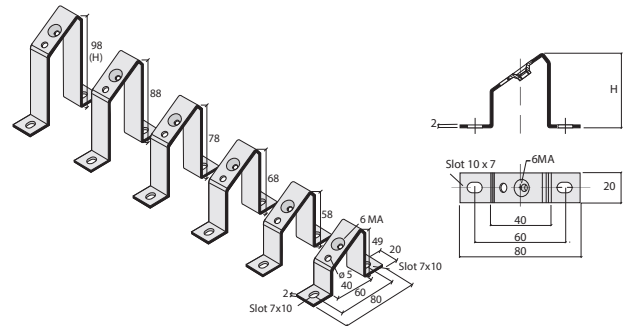
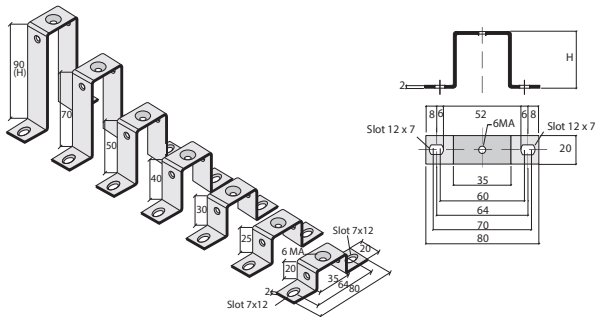

## Mounting clips



Mounting clips for mounting rail, allow installation of components which are not pre-set to clip on to rail. Material: nickel-plated steel.

| Order code | Type       | Weight (g) | Package (pcs) |
|------------|------------|------------|---------------|
| MMD5104A23 | FIX-KLIPM4 | 4          | 100           |
| MMD5105A23 | FIX-KLIPM5 | 4          | 100           |

