

Metal cable glands

IP68

Brass, stainless steel, EMC

Vibration- and UV-resistant

Heavy duty

Easy to assemble



Technical specifications

Material

- Cap nut and gland body: nickel-plated brass
- Clamping insert: polyamide PA6 V2
- Sealing ring: TPV
- O-ring: NBR

Properties

- Connection thread: metric (EN 60423) / PG (DIN 40430)
- Protection class: IP68 at up to 5 bar
- Temperature range: -20 °C +100 °C;
-40 °C +150 °C (short term)
- Easy to assemble
- Long thread versions available
- High strain relief



Order code	Thread (AG)	Dimensions (mm)		Hex B (mm)	Hex C (mm)	Cable diameter (mm)	Weight (g)	Package (pcs)
		H	GL					
MBM2ST12E0	M 12 x 1,5	22	6	14	14	3-6,5	12	100
MBM2ST16E0	M 16 x 1,5	23	7	18	17	4-8	18,4	50
MBM2ST20E0	M 20 x 1,5	26,5	8	22	22	6-12	29,2	50
MBM2ST20E1	M 20 x 1,5	26,5	8	22	22	4-10	30,05	50
MBM2ST25E0	M 25 x 1,5	28	8	27	24	10-14	36	25
MBM2ST32E0	M 32 x 1,5	31,5	9	34	30	13-18	67	20
MBM2ST40E0	M 40 x 1,5	38	9	43	40	18-25	138,6	10
MBM2ST50E0	M 50 x 1,5	43	9	55	50	22-32	231,4	5
MBM2ST63E0	M 63 x 1,5	48	14	68	64	33-44	414,4	5

Order code	Thread (AG)	Dimensions (mm)		Hex (mm)	Cable diameter (mm)	Weight (g)	Package (pcs)
		H	GL				
MBM1ST07E0	PG 7	22	6	14	3-6,5	11,8	100
MBM1ST09E0	PG 9	23	6	17	4-8	16,6	50
MBM1ST11E0	PG 11	24,5	6	20	5-10	23,2	50
MBM1ST13E0	PG 13,5	26,5	6,5	22	6-12	29,6	50
MBM1ST13E1	PG 13,5	26,5	6,5	22	4-10	29,8	50
MBM1ST16E0	PG 16	28	6,5	24	10-14	31,6	50
MBM1ST21E0	PG 21	31,5	7	30	13-18	55	25
MBM1ST29E0	PG 29	38	8	40	18-25	115,6	20
MBM1ST36E0	PG 36	43	10	50	22-32	198,4	10
MBM1ST42E0	PG 42	47	12	57	30-38	231,8	5
MBM1ST48E0	PG 48	48	14	64	33-44	344,8	5

Dimensions

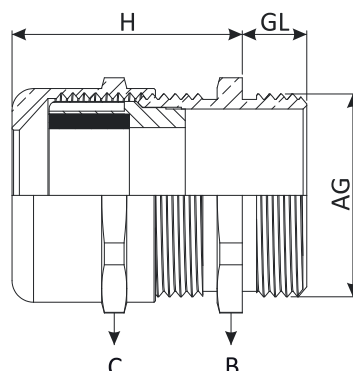

Technical specifications

Material

- Cap nut and gland body: stainless steel (1.4305 / AISI303-1.4404 / AISI316L)
- Clamping insert: polyamide PA6 V2
- Sealing ring: TPV
- O-ring: NBR

Properties

- Connection thread: metric (EN60423) / PG (DIN 40430)
- Protection class: IP68 - 5 bar
- Temperature range: -20 °C +100 °C; -40 °C +150 °C (short term)
- High corrosion resistance
- Smooth surfaces
- Easy to assemble
- Food, pharmaceutical industry and on-/offshore applications



Order code	Thread (AG)	Dimensions (mm)		Hex B (mm)	Hex C (mm)	Cable diameter (mm)	Weight (g)	Package (pcs)
		H	GL					
MBS2ST12E0	M 12 x 1,5	22	6	14	14	3-6,5	12,5	100
MBS2ST16E0	M 16 x 1,5	23	7	18	17	4-8	18,5	50
MBS2ST20E0	M 20 x 1,5	26,5	8	22	22	6-12	26	50
MBS2ST20E1	M 20 x 1,5	26,5	8	22	22	4-10	26,2	50
MBS2ST25E0	M 25 x 1,5	28	8	27	24	10-14	41	25
MBS2ST32E0	M 32 x 1,5	31,5	9	36	30	13-18	70	20
MBS2ST40E0	M 40 x 1,5	38	9	46	41	18-25	144,5	10
MBS2ST50E0	M 50 x 1,5	43	9	55	50	22-32	255	5
MBS2ST63E0	M 63 x 1,5	48	14	70	65	33-44	395,6	5

Order code	Thread (AG)	Dimensions (mm)		Hex (mm)	Cable diameter (mm)	Weight (g)	Package (pcs)
		H	GL				
MBS1ST07E0	PG 7	22	6	14	3-6,5	12,5	100
MBS1ST09E0	PG 9	23	6	17	4-8	16,6	50
MBS1ST11E0	PG 11	24,5	6	22	5-10	23,2	50
MBS1ST13E0	PG 13,5	26,5	6,5	22	6-12	29,6	50
MBS1ST13E1	PG 13,5	26,5	6,5	22	4-10	29,8	50
MBS1ST16E0	PG 16	28	6,5	24	10-14	31,6	50
MBS1ST21E0	PG 21	31,5	7	30	13-18	55	25
MBS1ST29E0	PG 29	38	8	41	18-25	115,6	20
MBS1ST36E0	PG 36	43	10	50	22-32	145	10
MBS1ST42E0	PG 42	47	12	60	30-38	255	5
MBS1ST48E0	PG 48	48	14	65	33-34	345	5

Dimensions

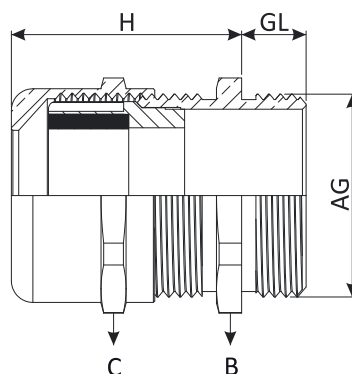

Technical specifications

Material

- Cap nut and gland body: nickel-plated brass
- Sealing ring: TPV / silicone / EPDM
- O-ring: NBR / TPV / silicone / EPDM

Properties

- Connection thread: metric (EN60423) / PG (DIN 40430)
- Protection class: IP68 at up to 3 bar
- Temperature range: -20 °C +100 °C;
-40 °C +150 °C
- Easy to assemble
- Long thread versions available
- Lighting industry



Order code	Thread (AG)	Dimensions (mm)		Hex (mm)	Cable diameter (mm)	Package (pcs)
		H	GL			
MBM2MI06E0	M 6 x 1,0	10,5	6	8	2-3	100
MBM2MI08E0	M 8 x 1,25	15	6	14	2-4	100
MBM2MI08E1	M 8 x 1,25	15	6	11	3-5	100
MBM2MI10E0	M 10 x 1,5	15	6	14	2-4	100
MBM2MI10E1	M 10 x 1,5	15	6	14	3-6	100
MBM2MI10E2	M 10 x 1,5	14,5	6	12	4-6	100
MBM2MI12E0	M 12 x 1,5	15	6	14	2-4	100
MBM2MI12E1	M 12 x 1,5	15	6	14	3-6	100
MBM1MI07E0	PG 7	15	6	14	2-4	100
MBM1MI07E1	PG 7	15	6	14	3-6	100
MBM1MI09E0	PG 9	16,5	6	17	4-6	100
MBM1MI09E1	PG 9	16,5	6	17	6-8	100

Dimensions

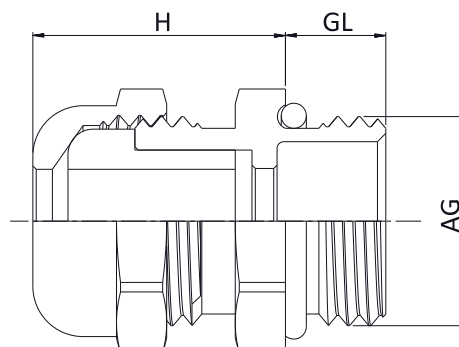

Technical specifications

Material

- Cap nut and gland body: nickel-plated brass
- Clamping insert: polyamide PA6 V2
- Sealing ring: TPV
- EMC spring: AISI301
- O-ring: NBR

Properties

- Connection thread: metric (EN60423) / PG (DIN 40430)
- Protection class: IP68 - 5 bar
- Temperature range: -20 °C +100 °C;
-40 °C +150 °C
- Easy to assemble
- For cables with shielding
- Suitable for cables with and without inner sheath
- Highly conductive



Order code	Thread (AG)	Dimensions (mm)		Hex B (mm)	Hex C (mm)	Cable diameter (mm)	Weight (g)	Package (pcs)
		H	GL					
MBM2EC12E0	M 12 x 1,5	22	6	14	14	3-6,5	12,5	100
MBM2EC16E0	M 16 x 1,5	23	7	18	17	4-8	18,5	50
MBM2EC20E0	M 20 x 1,5	26,5	8	22	22	6-12	26,5	50
MBM2EC25E0	M 25 x 1,5	28	8	27	24	10-14	42	25
MBM2EC32E0	M 32 x 1,5	32,5	9	34	30	13-18	72,5	20
MBM2EC40E0	M 40 x 1,5	38	9	43	40	18-25	144,5	10
MBM2EC50E0	M 50 x 1,5	48	9	55	50	22-32	255	5
MBM2EC63E0	M 63 x 1,5	53	14	68	64	34-44	395,5	5

Order code	Thread (AG)	Dimensions (mm)		Hex (mm)	Cable diameter (mm)	Weight (g)	Package (pcs)
		H	GL				
MBM1EC07E0	PG 7	22	6	14	3-6,5	16,5	100
MBM1EC09E0	PG 9	23	6	17	4-8	18,5	50
MBM1EC11E0	PG 11	26	6	20	5-10	25	50
MBM1EC13E0	PG 13,5	26,5	6,5	22	6-12	30	50
MBM1EC16E0	PG 16	28	6,5	24	10-14	37	50
MBM1EC21E0	PG 21	32,5	7	30	13-18	62,5	25
MBM1EC29E0	PG 29	38	8	40	18-25	128	20
MBM1EC36E0	PG 36	48	9	50	22-32	232,5	10
MBM1EC42E0	PG 42	48	12	58	30-38	252,5	5
MBM1EC48E0	PG 48	52	14	64	34-44	355	5

Dimensions

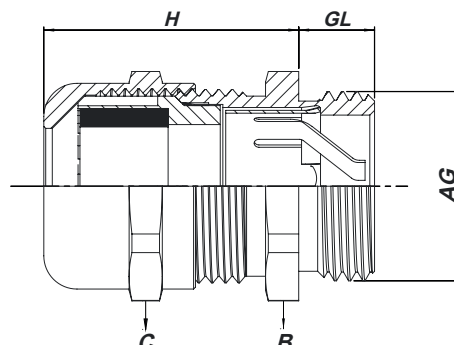

Technical specifications

Material

- Cap nut and gland body: nickel-plated brass
- Sealing ring: EPDM
- O-ring: NBR - TPV

Properties

- Connection thread: metric (EN60423)
- Protection class: IP68
- Temperature range: -20 °C +100 °C;
-40 °C +150 °C
- High impact and temperature resistance
- Easy to assemble
- Wide cable range
- XL cables



Order code	Thread (AG)	Dimensions (mm)		Hex B (mm)	Hex C (mm)	Cable diameter (mm)	Weight (g)	Package (pcs)
		H	GL					
MBM2XL63E0	M 63 x 1,5	48	15	70	75	45-55	515	5
MBM2XL75E0	M 75 x 1,5	48	20	85	75	45-55	700	2
MBM2XL75E1	M 75 x 1,5	58	20	90	90	50-63	700	2
MBM2XL80E0	M 80 x 2,0	58	20	90	90	50-63	870	2
MBM2XL90E0	M 90 x 2,0	61	20	100	100	60-70	1109	2
MBM3XL21E0	2 ½"	48	20	85	75	45-55	590,2	2
MBM3XL21E1	2 ½"	58	20	90	90	50-63	950	2
MBM3XL30E0	3"	61	20	100	100	60-70	1093,4	2

Dimensions

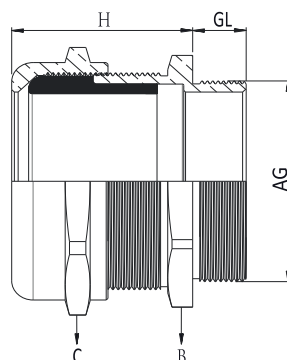

Technical specifications

Material

- Screw plug: nickel-plated brass
- Sealing ring: NBR

Properties

- Connection thread: metric (EN60423) / PG (DIN 40430)
- Protection class: IP68
- Temperature range: -40 °C +100 °C
- For unused threaded holes
- Assembly with a screwdriver
- Machine and equipment manufacturing
- Electric motor manufacturing



Order code	Thread (AG)	Dimensions (mm)			Weight (g)	Package (pcs)
		H	GL	D		
MBM2BS12E0	M 12 x 1,5	7,5	5	14	4,5	100
MBM2BS16E0	M 16 x 1,5	8	5	18	5,3	50
MBM2BS20E0	M 20 x 1,5	9,5	6,5	22	14,5	50
MBM2BS25E0	M 25 x 1,5	11	7	28	17	25
MBM2BS32E0	M 32 x 1,5	12	8	35	24,6	20
MBM2BS40E0	M 40 x 1,5	13	8,5	44	40,4	10
MBM2BS50E0	M 50 x 1,5	15	9	54	56,2	10
MBM2BS63E0	M 63 x 1,5	16	10	67	102,6	5

Order code	Thread (AG)	Dimensions (mm)			Weight (g)	Package (pcs)
		H	GL	D		
MBM1BS07E0	PG 7	8	5	14	3,7	100
MBM1BS09E0	PG 9	9	6	17	5,4	50
MBM1BS11E0	PG 11	9	6	20	7,9	50
MBM1BS13E0	PG 13,5	9,5	6,5	22	9,8	50
MBM1BS16E0	PG 16	9,5	6,5	24	15	50
MBM1BS21E0	PG 21	11	7	30	18,9	25
MBM1BS29E0	PG 29	12	8	39	69,4	20
MBM1BS36E0	PG 36	15	9	50	62,5	10
MBM1BS42E0	PG 42	16	10	57	86,1	5
MBM1BS48E0	PG 48	16	10	64	96,6	5

Dimensions

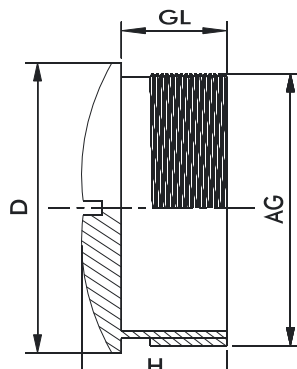

Technical specifications

Material

- Hexagonal locknut: nickel-plated brass
- Connection thread: metric (EN60423) / PG (DIN 40430)
- Temperature range: -60 °C +200 °C

Properties

- For tightening of cable glands



Order code	Thread (AG)	Dimensions (mm)			Weight (g)	Package (pcs)
		H	Hex (mm)			
MBM2LS12E0	M 12 x 1,5	2,8	15		1,6	100
MBM2LS16E0	M 16 x 1,5	3	19		3	50
MBM2LS20E0	M 20 x 1,5	3,5	24		5,4	50
MBM2LS25E0	M 25 x 1,5	3,5	30		8,2	25
MBM2LS32E0	M 32 x 1,5	4	36		10,6	20
MBM2LS40E0	M 40 x 1,5	4	45		16,4	10
MBM2LS50E0	M 50 x 1,5	5	55		26,8	5
MBM2LS63E0	M 63 x 1,5	5	68		37	5
MBM2LS75E0	M 75 x 1,5	7	90		150,4	10
MBM2LS80E0	M 80 x 2,0	7	90		165	10
MBM2LS90E0	M 90 x 2,0	10	100		202	10

Order code	Thread (AG)	Dimensions (mm)			Weight (g)	Package (pcs)
		H	Hex (mm)			
MBM1LS07E0	PG 7	2,8	15		1,8	100
MBM1LS09E0	PG 9	2,8	18		2,2	50
MBM1LS11E0	PG 11	3	21		2,8	50
MBM1LS13E0	PG 13,5	3	23		3,4	50
MBM1LS16E0	PG 16	3	26		4,4	50
MBM1LS21E0	PG 21	3,5	32		7,4	25
MBM1LS29E0	PG 29	4	40		10,2	20
MBM1LS36E0	PG 36	5	50		17,2	10
MBM1LS42E0	PG 42	5	60		32,6	5
MBM1LS48E0	PG 48	5,5	64		35,8	5

Dimensions

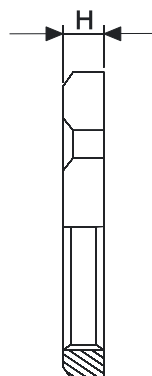

Technical specifications

Material

- Hexagonal locknut: stainless steel AISI303 / AISI316L
- Connection thread: metric (EN60423) / PG (DIN 40430)
- Temperature range: -60 °C +200 °C

Properties

- For tightening of stainless steel cable glands



Order code	Thread (AG)	Dimensions (mm)		Weight (g)	Package (pcs)
		H	Hex (mm)		
MBS2LS12E0	M 12 x 1,5	2,8	15	2	100
MBS2LS16E0	M 16 x 1,5	3	19	4	50
MBS2LS20E0	M 20 x 1,5	3,5	24	5	50
MBS2LS25E0	M 25 x 1,5	3,5	30	8,5	25
MBS2LS32E0	M 32 x 1,5	4	36	12	20
MBS2LS40E0	M 40 x 1,5	4	46	17	10
MBS2LS50E0	M 50 x 1,5	5	55	28	5
MBS2LS63E0	M 63 x 1,5	5	70	37	5

Order code	Thread (AG)	Dimensions (mm)		Weight (g)	Package (pcs)
		H	Hex (mm)		
MBS1LS07E0	PG 7	2,8	15	2	100
MBS1LS09E0	PG 9	2,8	18	3	50
MBS1LS11E0	PG 11	3	22	4	50
MBS1LS13E0	PG 13,5	3	24	5	50
MBS1LS16E0	PG 16	3	27	7	50
MBS1LS21E0	PG 21	3,5	32	8,5	25
MBS1LS29E0	PG 29	4	41	10,2	20
MBS1LS36E0	PG 36	5	50	10	17
MBS1LS42E0	PG 42	5	60	28	5
MBS1LS48E0	PG 48	5,5	65	35	5

Dimensions

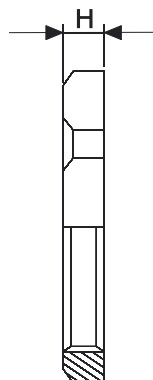

Technical specifications

Material

- Hexagonal locknut: nickel-plated brass;
Stainless steel AISI303 / AISI316L
- Connection thread: metric (EN60423) / PG (DIN 40430)
- Temperature range: -60 °C +200 °C

Properties

- For tightening of EMC cable glands



Order code Brass	Thread (AG)	Dimensions (mm)		Hex (mm)	Weight (g)	Package (pcs)
		H	S			
MBM2LS12E1	M 12 x 1,5	3,3	0,5	15	3	100
MBM2LS16E1	M 16 x 1,5	3,5	0,5	19	4	50
MBM2LS20E1	M 20 x 1,5	3,5	0,5	24	5	50
MBM2LS25E1	M 25 x 1,5	3,5	0,5	30	8,5	25
MBM2LS32E1	M 32 x 1,5	4,0	0,5	36	11	20
MBM2LS40E1	M 40 x 1,5	4,6	0,6	45	17	10
MBM2LS50E1	M 50 x 1,5	5,6	0,6	55	28	5
MBM2LS63E1	M 63 x 1,5	6,7	0,7	70	37	5
MBM2LS75E1	M 75 x 1,5	8,0	1,0	85	109	5

Order code Brass	Thread (AG)	Dimensions (mm)		Hex (mm)	Weight (g)	Package (pcs)
		H	S			
MBS1LS07E1	PG 7	3,3	0,5	15	3	100
MBS1LS09E1	PG 9	3,3	0,5	18	4	50
MBS1LS11E1	PG 11	3,5	0,5	21	5	50
MBS1LS13E1	PG 13,5	3,5	0,5	23	8	50
MBS1LS16E1	PG 16	3,5	0,5	26	11	50
MBS1LS21E1	PG 21	4,0	0,5	32	15	25
MBS1LS29E1	PG 29	4,6	0,6	40	19	20
MBS1LS36E1	PG 36	5,6	0,6	50	28	10
MBS1LS42E1	PG 42	5,6	0,6	60	37	5
MBS1LS48E1	PG 48	6,1	0,6	65	45	5

Dimensions

