

iDrive2 - XKL Series

- RS485/Modbus RTU built-in
- Up to 150% starting torque
- Detachable Keypad
- PID Control mode as standard
- Brake chopper built-in
- DC Injection braking
- 0-10V & 0-20mA analog inputs
- 4/5 Digital inputs
- Password function
- 2 year warranty
- IP20
- CE certified
- C2 & C3 filter options
- RoHS compliant
- Temp. range -10°C ~ 50°C



Detachable Keypad



iDrive2 (without filter)



C3 Filter

Options & Ordering Codes - iDrive2

XKL	—	150	—	21
Nominal Power			Input Voltage	
0.4kW		40		21 Input 200-240V ~ Single Phase
0.75kW		75		43 Input 380-440V ~ Three Phase
1.5kW		150		
2.2kW		220		

Options & Ordering Codes - Filters & Accessories

	iDrive 2	C3 Filter	Current	C2 Filter	Current
Single-Phase 230V	XKL-040-21	RFC3-3S	3A	RF29A-1A	29A
	XKL-075-21	RFC3-3S	3A	RF29A-1A	29A
	XKL-150-21	RFC3-10S	10A	RF29A-1A	29A
	XKL-220-21	RFC3-10S	10A	RF29A-1A	29A
Three-Phase 400V	XKL-075-43	RFC3-6	6A	RF15A-4A	15A
	XKL-150-43	RFC3-6	6A	RF15A-4A	15A
	XKL-220-43	RFC3-6	6A	RF15A-4A	15A

Accessories

XKL-KP	Additional Detachable Keypad
XKL-KP-MB	Keypad Mounting Bracket

iDrive2 - XKL Series

Specifications

	Model	Output Power (kW)	Input Current (A)	Output Current (A)	MCCB (A)	Cables (mm ²)
Single-phase 230V	XKL-040-21	0.4	6.5	2.5	16	1.5
	XKL-075-21	0.75	9.3	4.2	16	1.5
	XKL-150-21	1.5	15.7	7.5	25	2.5
	XKL-220-21	2.2	24	10	50	2.5
Three-phase 400V	XKL-075-43	0.75	3.2	2.5	10	1.5
	XKL-150-43	1.5	4.3	4.2	10	2.5
	XKL-220-43	2.2	7.1	5.5	16	2.5

Power and Control Connections

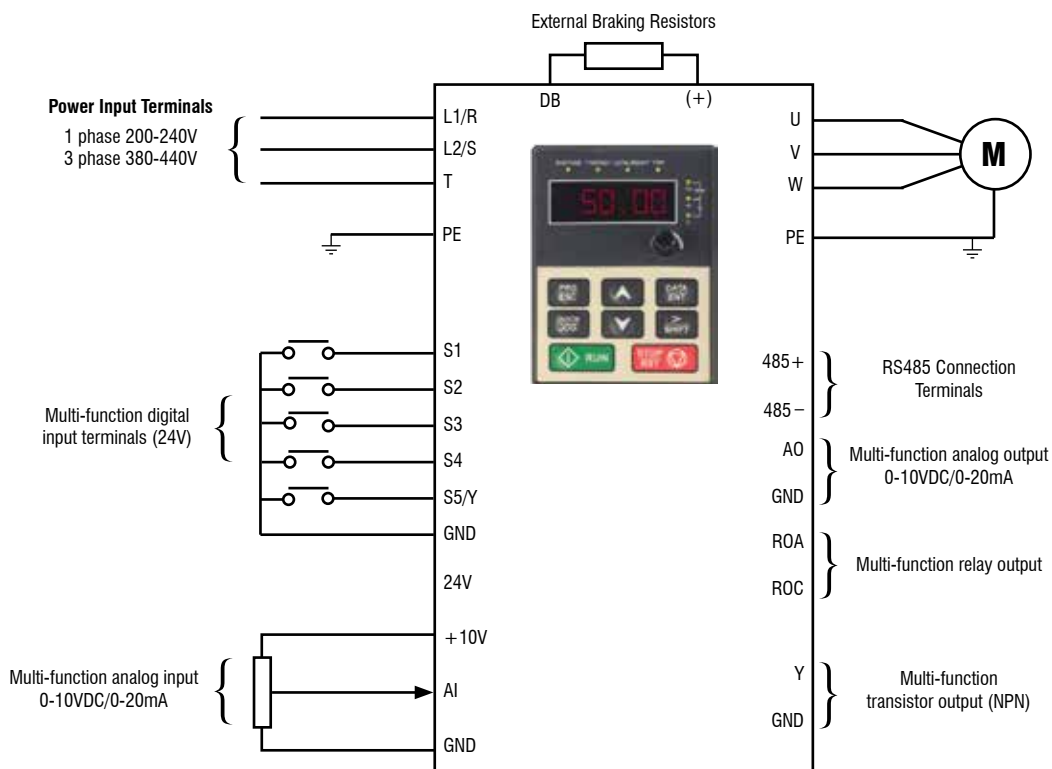

Dimensions (mm)

	Model	W1	W2	H1	H2	D
Single-phase 230V	XKL-040-21	85.0	74.0	145.5	131.5	134.2
	XKL-075-21	85.0	74.0	145.5	131.5	153.2
	XKL-150-21	100.0	89.0	170.5	154.0	153.2
	XKL-220-21	100.0	89.0	170.5	154.0	153.2
Three-phase 400V	XKL-075-43	85.0	74.0	145.5	131.5	153.2
	XKL-150-43	100.0	89.0	170.5	154.0	153.2
	XKL-220-43	100.0	89.0	170.5	154.0	153.2

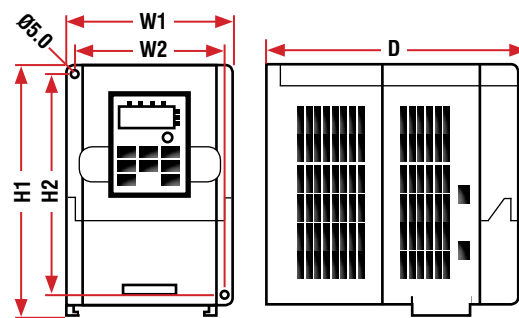

Wall mounting (unit: mm)